



**NAPCO**

**OPERATING AND INSTALLATION INSTRUCTIONS**

**MFA6000 SERIES  
FIRE ALARM CONTROL PANELS**

**TABLE OF CONTENTS**

<b>Section</b>	<b>Page</b>
1. INTRODUCTION.....	2
GENERAL DESCRIPTION.....	2
FEATURES.....	3
SPECIFICATIONS.....	4
ORDERING INFORMATION.....	6
RECOMMENDED UL-LISTED DEVICES.....	6
UL CLASSIFICATIONS.....	8
SUMMARY OF UL REQUIREMENTS.....	8
2. KEYPAD FUNCTIONS & OPERATION.....	10
OVERVIEW.....	10
KEYPAD FUNCTIONS.....	11
OPERATION.....	12
TESTING THE SYSTEM.....	15
3. PROM PROGRAMMING.....	17
PROGRAMMING MATERIALS.....	17
PROGRAMMING STEPS.....	17
PROGRAMMING RECORD SHEETS.....	19
GLOSSARY & PROGRAMMING INFORMATION.....	21
4. INSTALLATION.....	34
MOUNTING.....	34
GROUNDING.....	34
SYSTEM COMPONENTS.....	34
WIRING.....	35
COMPLETING THE INSTALLATION.....	38
WIRING DIAGRAMS.....	42
5. APPENDIX I: STANDBY BATTERY CALCULATION.....	44
APPENDIX II: TYPICAL FIRE INSTALLATION.....	45

INDEX STARTS ON PAGE 39.

(SEE PAGE 16 FOR A SUMMARY OF CHANGES FROM THE PREVIOUS EDITION.)

**INSTALLER:** IT IS IMPORTANT THAT YOU DEMONSTRATE THIS EQUIPMENT AND TEACH THE USER HOW TO OPERATE IT. BE SURE THAT THE USER RECEIVES THE OPERATING GUIDE (OI118) ACCOMPANYING THIS PRODUCT. IF THIS LITERATURE HAS BEEN LOST OR IS MISSING, IT WILL BE REPLACED BY NAPCO, WITHOUT CHARGE, UPON REQUEST. PLEASE SEE THAT THE USER COMPLETES AND RETURNS THE ENCLOSED WARRANTY REGISTRATION CARD IN ORDER TO RECEIVE PRODUCT UPDATES AND/OR ANNOUNCEMENTS.

**UL LISTED:** SIGNAL SYSTEM CONTROL UNIT; ALSO SUITABLE AS HOUSEHOLD FIRE CONTROL UNIT

## 1. INTRODUCTION

### GENERAL DESCRIPTION

Magnum Fire Alert-6000-Series panels are 4-zone microcomputer-based fire control units with provisions for digital communication for central-station operation, or line reversal for remote station operation. The MFA6000 Series comprises the MFA6024 and the MFA6012, which operate with 24-volt and 12-volt initiating and signalling devices and accessories, respectively.

Each system is contained within a wall-mounted enclosure and includes a preprogrammed PROM (Programmable Read-Only Memory) and an integral multifunction digital keypad. Five LEDs (Light-Emitting Diodes), a numeric display and a mini-sounder provide visual and audible indication of zone and system status.

**NOTE:** No programming is needed for local operation with standard features. Use a Napco PRO-410/410M to program custom features.

The on-board digital keypad allows the user to

- silence an alarm
- reset zones/system
- test system/zones
- disable a zone
- disable an output device
- enable a zone
- enable an output device
- display zones disabled
- display system trouble
- display zones in trouble
- display zones in alarm
- display last alarm (alarm history)

The numeric display indicates

- zones in alarm
- zones in trouble
- system troubles
- zones disabled
- alarm history

Five LEDs indicate

- alarm
- zone trouble
- system trouble
- zone disabled
- ac power

The mini-sounder indicates

- zone trouble
- system trouble
- 24-hour trouble reminder (programmable)
- keypad digit beep (programmable)
- trouble resound

**NOTE: CHECK LOCAL CODES BEFORE INSTALLING A FIRE ALARM SYSTEM.**

## **FEATURES**

### **Initiating Circuits**

- four Class-B zones capable of supplying power for up to 30 two-wire UL-listed smoke detectors per loop (MFAG024 only)
- accommodates pull stations, waterflow devices, four-wire smoke detectors and thermostats
- supervisory loop for sprinkler supervisory devices
- programmable for waterflow operation and waterflow retard
- programmable for pre-signal operation
- programmable smoke-detector power-up time prevents re-arming of smoke detector zones after power restoral
- alarm verification

### **Outputs**

- two independently-supervised signal circuits (controlled by a common relay)
- auxiliary alarm relay contacts
- trouble relay contacts
- programmable time-outs for signal circuit and relays
- fwr (full-wave-rectified) power supply
- resettable regulated 4-wire smoke detector power supply

### **Central-Station Signalling (DD6000)**

- optional DD6000 will supervise two telephone lines
- 6 receiver formats, including BFSK
- Extended/Single-Digit, Single-Digit, Two-Digit and Sum-Check data formats
- alarm and restoral codes for each zone, zone trouble and system trouble
- 24-hour test report timer with separate alarm code and subscriber identification code
- status reporting
- backup reporting
- Touch-Tone(R) dialing
- Touch-Tone(R) dialing with rotary backup
- two telephone numbers

### **Remote-Station Signalling Options**

- M6000
- M278

**MFA6024 SPECIFICATIONS**

Operating Temperature: 0-49 degrees C (32-120 degrees F)  
 Input Power: 120Vac/60Hz; 135W maximum  
 Battery Power: See Table 1 (below)  
 Initiating Loops: 16.25-28.8Vdc; Standby, 11mA max. incl. EOL, 3mA available; Alarm, limited to 37mA; No. of Smoke Detectors\*: System Sensor, 23 (30 for Model 2300T); ESL, 30; Fenwal, 30, 2.7k, 1/2W EOL resistor, Wiring Resistance, 100 ohms max.; Alarm Threshold Impedance, 1k max.  
 Supervisory Loop: 24Vdc (open circuit), 7.0mA max.  
 Alarm Signal Circuits: 2 supervised full-wave-rectified outputs; 24Vfw, 2A max. 10k EOL resistor (see Combined Alarm Currents).  
 Signal-Circuit Resistance: (see INSTALLATION)  
 Auxiliary Alarm Relay: SPDT isolated contacts; 24Vdc/3A resistive  
 Trouble Relay: SPDT isolated contacts; 24Vdc/3A resistive  
 FWR Power Output: Continuous 24Vfw full-wave rectified; 3mA min. to 500mA max. (See Combined Alarm and Standby Currents).  
 4-Wire Smoke-Detector Power: 16.25-28.8Vdc regulated, 250mA max (see Combined Standby Current)  
 Remote Power: 12Vdc, 100mA max. (2 RP6000s) (Subtract from Combined Standby Current, below)  
 Combined Current, Standby: 250mA max. (4-Wire Smoke Power, Remote Power, FWR Output in Standby; includes 1 DD6000 or M6000)  
 Alarm: 2.5A max. (signal circuits; FWR output)  
 Low-Battery Signal: 21.0Vdc  
 Remote Annunciator, Maximum Number: 2  
 Current (each): 30mA, excluding sounder; 50mA with remote sounder  
 Fuses  
 Battery: 5A, 1AG (F1)  
 Smoke-Detector Power: 1/2A, 1AG (F2)  
 Signal Circuit 1: 3A/1AG (F4)  
 Signal Circuit 2: 3A/1AG (F5)  
 Dimensions: 17.8"H x 14.4"W x 5.5"D  
 Shipping Weight: 20 lb (approx.)

24 HOURS STANDBY TIME	
COMBINED STANDBY CURRENT	BATTERY CAPACITY
250mA max	12AH min
100	8
30	6

60 HOURS STANDBY TIME	
COMBINED STANDBY CURRENT	BATTERY CAPACITY
155mA max	24AH min
75	18
50	16

NOTE: 24 hours standby is required for Local or Central Station; 60 hours standby is required for Remote Station or Auxiliary Protected Premises. See Appendix I. Standby Battery Calculation.

Table 1. Battery capacity (ampere-hours) for various combined standby-current loads, MFA6024.

\*If mixing brands of smoke detectors, limit total number to 23.

## MFA6012 SPECIFICATIONS

Operating Temperature: 0-49 degrees C (32-120 degrees F)  
 Input Power: 120Vac/60Hz; 135W maximum  
 Battery Power: See Table 1 (below)  
 Initiating Loops: 8.5-12.8Vdc; Standby, 11.2mA max. including EOL, 1.2mA available; Alarm, limited to 34mA; EOL, 1.2k, 1/2W  
 Wiring Resistance: 20 ohms max.  
 Alarm Threshold Imp.: 600 ohms max.  
 Two-Wire Smokes/Zone: 10 max.  
 Supervisory Loop: 12Vdc (open circuit), 7.0mA max.  
 Alarm Signal Circuits: 2 supervised full-wave-rectified outputs; 12Vfw, 2A max. 10k EOL resistor (see Combined Alarm Currents).  
 Signal-Circuit Resistance: (see **INSTALLATION**)  
 Auxiliary Alarm Relay: SPDT isolated contacts; 24Vdc/3A resistive  
 Trouble Relay: SPDT isolated contacts; 24Vdc/3A resistive  
 FWR Power Output: Continuous 12Vfw full-wave rectified; 3mA min. to 500mA max. (See Combined Alarm and Standby Currents).  
 4-Wire Smoke-Detector Power: 8.5-12.8Vdc regulated, 250mA max. (see Combined Standby Current)  
 Remote Power: 12Vdc, 100mA max. (2 RP6000s) (Subtract from Combined Standby Current, below)  
 Combined Current, Standby: 250mA max. (4-Wire Smoke Power, Remote Power, FWR Output in Standby; includes 1 DD6000 or M6000)  
 Alarm: 2.5A max. (signal circuits; FWR output)  
 Low-Battery Signal: 11.0Vdc  
 Remote Annunciator, Maximum Number: 2  
 Current (each): 30mA, excluding sounder; 50mA with remote sounder  
 Fuses  
 Battery: 5A, 1AG (F1)  
 Smoke-Detector Power: 1/2A, 1AG (F2)  
 Signal Circuit 1: 3A/1AG (F4)  
 Signal Circuit 2: 3A/1AG (F5)  
 Dimensions: 17.8"H x 14.4"W x 5.5"D  
 Shipping Weight: 20 lb (approx.)

24 HOURS STANDBY TIME	
COMBINED STANDBY CURRENT	BATTERY CAPACITY
250mA max	12AH min
100	8
30	6

60 HOURS STANDBY TIME	
COMBINED STANDBY CURRENT	BATTERY CAPACITY
250mA max	30AH min
155	24
75	18
50	16
0	12

NOTE. 24 hours standby is required for Local or Central Station; 60 hours standby is required for Remote Station or Auxiliary Protected Premises. See **Appendix I. Standby Battery Calculation.**

Table 2. Battery capacity (ampere-hours) for various combined standby-current loads, MFA6012.

**ORDERING INFORMATION (\*UL-Listed Subassembly; \*\*UL-Listed Accessory)**

MFA6024 4-zone fire control unit with DD496 preprogrammed PROM and integral keypad  
MFA6012 MFA6024 is for use with 24-volt devices; MFA6012 for 12-volt devices.  
RP6000\*\* Remote Annunciator  
CA6000 Class-A Module  
DD6000\* Dual-Line Digital Communicator  
DD6010 Single-Line Digital Communicator  
M6000\* Polarity-Reversal Module (with Municipal Box Connection)  
R6000\* Remote Interface Module  
M278\* Line-Reversal Module  
EOL1.2K\*\* End-of-Line Resistor, 1.2k ohms (for MFA6012)  
EOL2.7K\*\* End-of-Line Resistor, 2.7k ohms (for MFA6024)  
EOL10K\*\* End-of-Line Resistor, 10k ohms  
DD496 Preprogrammed PROM  
DD493BNK Blank PROM  
RBAT-4 12-volt rechargeable battery, 4AH  
RBAT-6 12-volt rechargeable battery, 6AH  
RBAT-H1 Dual Battery Harness  
RBAT-H2 Battery Jumper  
WL1 Wire Assembly with "Faston" connector, 20"  
MFA-FM1 Flush Mounting Hardware  
PF156 Programming Record Sheets, 100/pad  
OI118 Operating Guide  
A238 Dealer Brochure

**RECOMMENDED UL-LISTED DEVICES (\*Not for use in UL Residential Installations)**

NOTE: UL-listed or FM-approved open-circuit devices, such as pull stations, thermostats, heat detectors, etc., that do not require power from the MFA6000, that have dry, latching, normally-open alarm contact outputs and dry, latching, normally-closed trouble output contacts, may be used if acceptable to the authority having jurisdiction. Note: 24V units are for MFA6024 only; 12V units are for MFA6012 only.

**Bells/Strobe Bells:**

- Amseco, 24V: MSB6B-PV424; MSB8B-PV424; MSB10B-PV424; EXB6B-PV424\*; EXB8B-PV424\*; EXB10B-PV424\*
- Edwards, 24V: 439D-8AW\*; 439D-10AW\*
- Edwards, 12V: 439D-8AW-R\*; 439D-10AW-R\*
- Faraday, 24V: 4461-10-14-24-DC\*; 4464-4-14-24-DC\*; 4466-6-14-24-DC\*; 4468-8-14-24-DC\*
- Hochiki America, 24V: AL-VB-624\*; AL-VB-824\*; AL-VB-1024\*; AL-MB-624\*; AL-MB-824\*; AL-MB-1024\*; AL-MTR-624\*
- Hochiki America, 12V: AL-VB-612\*; AL-VB-812\*; AL-VB-1012\*; AL-MB-612\*; AL-MB-812\*; AL-MB-1012\*
- Wheelock, 24V: 46T-G4-24-R\*; 46T-G6-24-R; 46T-G10-24-R; 42PT-G6-24-R\*; 42PT-G10-24-R\*; 46T-G6-24-WS-24-HF-R; 46T-G10-24-WS-24-HF-R
- Wheelock, 12V: 46T-G4-12-R\*; 46T-G6-12-R; 46T-G10-12-R; 46T-G6-12-WS-12-HF-R; 46T-G10-12-WS-12-HF-R

**Horns/Strobe Horns:**

- Edwards, 24V: 882-1B\*; 882-2B\*; 892-1B\*; 892-2B\*
- Faraday, 24V: 6120-0-0-24-DC\*
- Faraday, 12V: 6120-0-0-12-DC\*
- Federal Signal, 24V: Horns: 450 Series\* (only those rated at 18-31.2V); Strobes: VALS Series\* (only those rated at 18-31.2V)

- Gentex, 24V: SHG-24H
- Gentex, 12V: SHG-12H
- Hochiki America, 24V: AL-MH-24\*
- Hochiki America, 12V: AL-FH-12\*
- Wheelock, 24V: 34T-24-R; 36T-24-R; 7002T-24-W-FR; 7001T-24-W-FR; V7001T-24-W-FR
- Wheelock, 12V: 34T-12-R; 7002T-12-W-FR; 7001T-12-W-FR; V2001T-12-W-FR

Chimes/Strobe Chimes:

- Faraday, 24V: 4465-0-14-24-DC\*
- Wheelock, 24V: CH-BF1-R\*; CH-BF1-WS-24-HF-R\*; CH-CF1-W\*; CH-CF1-WS-24-CF-W\*; CH-DF1-R\*; CH-DF1-WS-24-VF-R\*
- Wheelock, 12V: CH-BF2-R\*; CH-BF2-WS-12-HF-R\*; CH-CF2-W\*; CH-CF2-WS-12-CF-W\*; CH-DF2-R\*; CH-DF2-WS-12-VF-R\*

Strobes:

- Edwards, 24V: 894B-001
- Hochiki America, 24V: AL-SL-24
- Wheelock, 24V: WMT-24FR; WMIT-24FR; WM3T-24-FR

Electronic Signals:

- Wheelock, 24V: ES-BH1-R; ES-BH1-WH-24-HF-R; ES-DL1-R; ES-DL1-WS-24-VF-R; ES-EL1-R; ES-EL1-WS-24-HF-R
- Wheelock, 12V: ES-BH2-R; ES-BH2-WH-12-HF-R; ES-DL2-R; ES-DL2-WS-12-VF-R; ES-EL2-R; ES-EL2-WS-12-HF-R
- System Sensor. 24V: MA12/24I\* Multi-Tone Horn

Smoke Detectors. Two-Wire Type:

- Detection Systems, Inc., 24V: DS200 with MB200-2W Base
- ESL, 24V (Compatibility ID "S10"): 425C, 425CT (includes base); 612U; 611U, 611UT, each with 601U Base (Base ID "S00"); 609U01 (611UD Duct Detector with 609U00 Enclosure and 609U10 Function Card) (Function Card ID "S00"); 609U02 (612UD Duct Detector with 609U00 Enclosure and 609U10 Function Card) (Function Card ID "S00")
- Fenwal, 24V (Compatibility ID in parentheses): CPD-7021 (I1FE1), PSD-7125 (P5FE1), PSD-7126 (P6FE1), PSD-7130 (P10FE1), PSD-7131 (P11FE1), with bases 70-201000-001 (FE01A), 70-201000-002 (FE02A) and 70-201000-003 (FE03A); CPD-7021 (I1FE1), PSD-7129 (P9FE1) with 70-211002-000 Duct Unit DH-22 (D22FE1)
- System Sensor (Compatibility ID "A"): 1400, 2400, 2400TH, each with B101B Base; 1451, 2451, 2451TH, each with B401B Base; 2300T (2312/24T) with adaptor bracket; 2851DH with DH2852DC Duct Detector Housing; 1851DH with DH1851DC Duct Detector Housing

Smoke Detectors. Four-Wire Type:

- Alph-Alarm, 24V: SPA-24B
- Detection Systems, Inc., 24V: DS200 with MB200-4W Base
- ESL: 445C, 445CT, 445CR, 445CRT
- Gentex, 12V: 812, 812T, 812P, 812PT, 812PH; 8120, 8120T, 8120P, 8120PT, 8120PH
- Hochiki America, 24V: SLK-24F, SLK-24FH, SIF-24F, each with HS-2RB/4 Base
- Hochiki America, 12V: SLG-12 with YBC-RL4-RA Base
- System Sensor: 1851B; 2851B, 2851BTH, each with B102B Base; 2851DH with DH2851DC Duct Detector Housing and AR-10 Relay; 1851DH with DH1851DC Duct Detector Housing and AR-10 Relay

## U.L. CLASSIFICATIONS

Local Control Unit (non-coded); also suitable as Central Station Premises Control Unit when used with DD6000 Digital Communicator; Remote Station Protected Premises Control Unit or Auxiliary Protected Premises Control Unit with local energy (series) municipal box connection when used with M6000 Polarity Reversal Module.

Type of Signalling Service: Manual fire alarm; automatic fire alarm; waterflow alarm; sprinkler supervisory.

## SUMMARY OF U.L. REQUIREMENTS

### General

- Refer to NFPA codes (71, 72A, 72B, 72C).
- Observe all specifications and wiring diagram instructions.
- Check local codes with the authority having jurisdiction.
- Use only recommended smoke detectors, signalling devices, and rated standby-battery capacities. Refer to the battery chart under SPECIFICATIONS to select a battery, or combination of batteries, that will meet or exceed the required capacity.
- Use only smoke detectors on zones programmed for *Alarm Verification*.
- For *Alarm Verification*, do not program any additional smoke-detector power-up time (locations 204-205). Program an "E" in location 202 and a "2" in location 203 to create a verification power down time of 11.5 seconds. Do not program a longer time. The total delay (control unit plus smoke-detector power-up time, see label inside control-unit door) may not exceed 60 seconds.

### Local Systems (NFPA 72A)

- 24-Hour Standby required.
- If using a pre-signal sounding device, the device must be installed in the same room as the control unit, with conduit or similar mechanical protection.
- Do not program *Inhibit Signal Circuit Alarm* for Fire Zones 1-4.

### Central Station (NFPA 71)

- 24-Hour Standby required.
- Install the DD6000 Digital Communicator.
- Connect two separate incoming telephone lines.
- Loop start is required. Ground start is not permissible.
- *Report on Alarm* and *Restoral Report* programming is required on all zones and all troubles (program an "F" in locations 166-172 and a "7" in location 173). The central station must be able to distinguish between a fire alarm/restoral; fire trouble/restoral; and waterflow supervisory/restoral. System troubles/restorals (other than supervisory/restoral) may share a common



code.

- Backup Reporting is automatic. Program a telephone number in *Telephone #1* locations 114-131. A different telephone number must be programmed in *Telephone #2* locations 146-163.
- The digital communicator must report to one of the following compatible receivers:

Receiver	Format (See Programming Sheet)
Ademco 685	Ademco/Silent Knight <i>slow</i>
FBI CP-220B	All Formats
Radionics D6000, D6500	All Formats
SESCOA 3000C, 3000R	SESCOA
Silent Knight 8510, 8520	Ademco/Silent Knight <i>slow</i> ; SESCOA

**NOTE:** U.L. central-station installations using a digital communicator are required to be connected to the public switched telephone network upstream of any private telephone system at the protected premises. *Call Party Disconnect* is automatic.

- Maximum number of devices:

Waterflow devices per zone	5
Sprinkler supervisory devices per zone	20

#### Remote Station (NFPA 72C)

- 60-Hour Standby required
- Install M6000 Polarity-Reversal Module (the M278 may be used as an alternative or as a separate line for trouble)
- Program *Polarity Reversal Alarm Operation* ("1" in location 195) if using M6000
- Alarms on Zones 1-4 will automatically activate the M6000
- Use auxiliary alarm relay contacts to activate the M278 for alarms. Do not program *Inhibit Auxiliary Alarm Relay* for Fire Zones 1-4. The trouble relay contacts may be used to activate an M278 for troubles. Do not program *Inhibit Trouble Relay*. Do not program a time-out for either relay.

#### Auxiliary Protective Systems (NFPA 72B)

- 60-Hour Standby required
- Install M6000 Polarity-Reversal Module
- Listed Local energy (series) municipal box connection with 14.5-ohm coil may be used.
- Program *Polarity Reversal Alarm Operation* ("1" in location 195)
- Alarms on Zones 1-4 will automatically activate the M6000

## 2. KEYPAD FUNCTIONS & OPERATION

### OVERVIEW

This section provides simplified instructions for local operation of MFA6000-Series Fire Alarm Control Panels having no special-feature programming. Read this section first to gain familiarity with the operation of the keypad and panel. Comprehensive instructions are provided in the section that follows.

**Main Keypad.** The main keypad is inside the control-panel enclosure, which is normally kept locked, thus eliminating the need for an access code. The keypad contains five LEDs (light-emitting diodes), a numeric display, and 10 pushbuttons. The LEDs indicate *ALARM*, *ZONE TROUBLE*, *SYSTEM TROUBLE*, *ZONE DISABLED*, and *AC ON*. The numeric display will indicate the number(s) of the zone(s) in alarm, zone(s) in trouble, or zone(s) that have been disabled. Coded system troubles are also shown on the numeric display.

For information on enabling and disabling zones, recall keys, and system tests, refer to **OPERATION**.

**Initiating Zones.** The MFA6000 comprises four Class-B detection zones. These are end-of-line-resistor supervised and will support devices such as smoke detectors, heat detectors and pull stations.

**Alarm Detection.** When an alarm is initiated on any of Zones 1 through 4, the signal circuits will activate, the auxiliary alarm relay will activate, the keypad ALARM LED will flash, and the keypad numeric display will indicate the zone(s) in alarm.

**Silencing an Alarm.** If the [SILENCE] button on the keypad is pressed, the signal circuits will deactivate, the keypad numeric display will go out, and the keypad ALARM LED will glow steadily.

**Resetting an Alarm.** The panel may be reset after the initiating device (smoke detector, pull station, etc.) has been restored, by pressing the keypad [RESET] button. This will, after a brief delay, turn off the signals (if not previously silenced), and the keypad ALARM LED. The ALARM LED will remain on until the panel is reset, but the panel will not reset unless all tripped zones are restored. Press the [ALARM] button to display the zones in alarm.

**Zone Trouble.** If the detection loop of any of Zones 1 through 4 opens, the mini-sounder will beep continuously, the ZONE TROUBLE LED will blink, the numeric display will indicate the zone in trouble.

**Silencing a Zone Trouble.** If the [SILENCE] button is pressed, the mini-sounder will shut off, the ZONE TROUBLE LED will glow steadily (if the zone is still in trouble), the numeric display will go out, and the trouble relay will deactivate.

**Trouble Resound.** If the keypad [SILENCE] button had been pressed and the zone or system trouble corrected (or zone enabled), the sounder will sound and the respective LED will blink repeatedly. This indicates that the zone has been repaired (or enabled). To silence this indication, press the keypad [SILENCE] button.

**RP6000 Remote Annunciator.** Except for the AC ON LED, the RP6000 Remote Annunciator contains the same indicators as the main-panel keypad. The [TROUBLE SILENCE] button will silence only the mini-sounder inside the remote annunciator; it will not affect any other indications, either at the RP6000 or at the control panel.

**External Reset Switch.** Lugs E23 and E24 (see Wiring Diagram) provide for the addition of an optional external Reset keyswitch to permit resetting the panel without opening the enclosure. Use a UL-listed normally-open momentary-contact keyswitch rated at 0.25A/12V, minimum. Connection may be made using two Napco WL1 Wire Assemblies (see ORDERING INFORMATION).

**External Silence Switch.** This optional keyswitch is mounted at the side of the panel enclosure, and has the same function as the [SILENCE] button on the keypad inside. It provides a means of silencing an alarm or trouble without opening the cabinet door.

**KEYPAD FUNCTIONS**

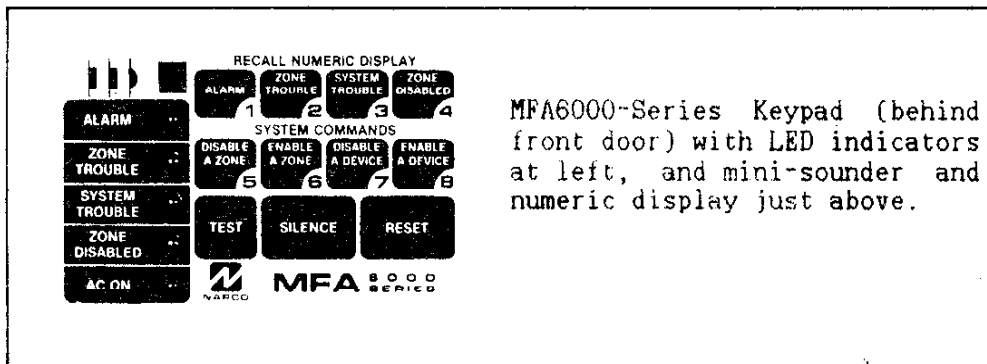

MFA6000-Series Keypad (behind front door) with LED indicators at left, and mini-sounder and numeric display just above.

**TEST** - (with numeric key) allows the user or installer to access any one of four test modes. Refer to **TESTING THE SYSTEM**.

**SILENCE** - silences the mini-sounder or alarm device during an alarm or trouble condition and clears the numeric display.

**RESET** - resets a zone after the alarm device has been restored. Momentarily removes power from a zone (and also 4-wire smoke-detector power) in order to reset devices that require removal of power for resetting.

**DISABLE A ZONE** - (with numeric key) disables any zone 1 through 4.

**ENABLE A ZONE** - (with numeric key) enables a zone that had been previously disabled.

**DISABLE A DEVICE** - (with numeric key) disables any output device.

**ENABLE A DEVICE** - (with numeric key) enables an output device that had been previously disabled.

**ALARM** - displays the current alarm condition on the numeric display. After all alarms have been reset, pressing this button will cause the last zone that was in alarm to be shown on the numeric display.

**ZONE TROUBLE** - indicates (on the numeric display) any zone that is in trouble.

**SYSTEM TROUBLE** - displays system troubles or sprinkler-supervisory activation, as follows

- "1" - Ac Failure
- "2" - Sprinkler Supervisory Activation
- "3" - (without LED\*) Signal-Circuit Trouble
- "3" - (with LED\*) Sprinkler Supervisory Trouble
- "4" - Ground Fault
- "5" - Telephone-Line Trouble (when DD6000 is installed)
- "6" - Disabled Device
- "7" - Battery Trouble
- "8" - Program Failure

\* LED located at upper-left corner of circuit board.

**ZONE DISABLED** - displays each zone that has been disabled.

## OPERATION

**Standby Mode.** Under normal conditions, that is, when no trouble or alarm condition exists, the panel is in Standby. In this mode, only the green AC ON LED will be lit. If the AC ON LED is not lit, ac power is low or lost. Check for a power-line problem.

**Alarm.** Should an alarm occur, the alarm device (bell, horn, etc.) will sound and the red ALARM LED will flash. The zone in alarm will appear on the numeric display.

To silence the alarm device, press the [SILENCE] button. The device will shut off and the numeric display will go blank, but the red ALARM LED will remain on steady as a reminder that an alarm condition still exists. To recall the zone number on the numeric display, press the [ALARM] button.

If a waterflow zone is in alarm, the alarm device cannot be shut off unless the alarm condition is removed. To reset an alarm on a waterflow zone, press [RESET] after the alarm condition is cleared. After a brief delay, the ALARM LED and the display will

go out.

To reset a fire alarm zone after having silenced the alarm device, restore the initiating device (reset the pull station, clear smoke from the smoke detector, etc.), then press [RESET]. After a brief delay, the ALARM LED will go out.

**Zone Trouble.** A trouble condition on any zone will cause the yellow ZONE TROUBLE LED to flash and the mini-sounder to pulse; the zone in trouble will appear on the display. To silence the sounder, press the [SILENCE] button; the sounder will shut off and the display will go blank, but the yellow ZONE TROUBLE LED will remain on steady as a reminder that a trouble condition still exists. To recall the zone number on the display, press the [ZONE TROUBLE] button. **NOTE:** If a zone trouble condition has corrected itself, the sounder will have shut off however the display will continue to flash the zone number. Press the [SILENCE] button to clear the display.

To reset a zone trouble, correct the trouble condition. If the zone trouble had been previously silenced, correcting the condition will cause a trouble resound at the keypad. That is, the ZONE TROUBLE LED will flash and the mini-sounder will come on continuously. To silence the resound indication, press [SILENCE]. The mini-sounder will shut off and the LED will go out. (If Inhibit Zone Trouble Resound has been programmed, there will be no resound indication. The ZONE TROUBLE LED will go out when all trouble conditions are corrected.)

**System Trouble.** Any system trouble condition will cause the yellow SYSTEM TROUBLE LED to flash and the mini-sounder to pulse; the system trouble code will appear on the numeric display. To silence the sounder, press the [SILENCE] button. The sounder will shut off and the display will go blank, but the yellow SYSTEM TROUBLE LED will remain on as a reminder that a trouble condition still exists. To recall the system trouble number on the display, press the [SYSTEM TROUBLE] button. **NOTE:** If a system trouble condition has corrected itself, the sounder will have shut off however the display will continue to flash the system trouble code. Press the [SILENCE] button to clear the display.

**NOTE:** An "8" on the numeric display and a pulsing sounder indicate failure of the PROM. Failure of the microprocessor IC will cause a steady sounder indication. Remove power and check that the PROM is inserted correctly. If the trouble is not corrected when power is reapplied, service arrangements should be made.

To reset a system trouble, correct the trouble condition. If the system trouble had been previously silenced, correcting the condition will cause a trouble resound at the keypad. That is, the SYSTEM TROUBLE LED will flash and the mini-sounder will come on continuously. To silence the resound indication, press [SILENCE]. The mini-sounder will shut off and the LED will go out. (If Inhibit System Trouble Resound has been programmed, there will be no resound indication. The SYSTEM TROUBLE LED will go out when

all trouble conditions are corrected.)

**Disabling/Enabling a Zone.** To disable any zone, press the button labelled [DISABLE A ZONE], followed by the zone number. The yellow ZONE DISABLED LED will flash, the mini-sounder will beep intermittently, and the disabled zone will appear on the numeric display. To silence the sounder, press the [SILENCE] button. The sounder will shut off and the numeric display will go blank, but the LED will remain on as a reminder that a zone is still disabled. When a zone is disabled, the trouble relay will always activate, even if Inhibit Trouble Relay has been programmed for a zone trouble. To recall the zone number on the numeric display, press the [ZONE DISABLED] button.

To enable the zone, press the [ENABLE A ZONE] button, followed by the zone number. This will cause a trouble resound; the ZONE DISABLE LED will flash and the mini-sounder will sound continuously. To silence the resound indication, press [SILENCE]. The mini-sounder will shut off and the LED will go out. (If Inhibit Zone-Enable Resound has been programmed, there will be no resound indication. The ZONE ENABLE LED will go out when all the zones are enabled.)

**Disabling/Enabling a Device.** To disable any device, press the [DISABLE A DEVICE] button, followed by the device number: [1] Signal Circuits; [2] Auxiliary Alarm Relay; [3] Trouble Relay; [4] Digital Communicator.

The yellow SYSTEM TROUBLE LED will flash, the mini-sounder will beep intermittently, and a "6" (Device(s) Disabled) will appear on the numeric display. Disabling additional devices will not be indicated. To silence the sounder, press the [SILENCE] button. The sounder will shut off and the numeric display will go blank, but the LED will remain on as a reminder that a device is still disabled. To recall the trouble number on the numeric display, press the [SYSTEM TROUBLE] button.

To enable the device, press the [ENABLE A DEVICE] button, then the device number. When all devices have been enabled, a trouble resound will occur at the keypad; the SYSTEM TROUBLE LED will flash and the mini-sounder will come on continuously. To silence the resound indication, press [SILENCE]. The mini-sounder will shut off and the LED will go out. (If Inhibit System Trouble Resound has been programmed, there will be no resound indication. The SYSTEM TROUBLE LED will go out when all the trouble conditions are corrected.)

## TESTING THE SYSTEM

There are four tests that may be made to check system operation.

**Test #1 - One-Man Test.** This will check individual initiating devices and associated wiring. To invoke Test #1,

1. Disable the zone to be tested by pressing the [DISABLE A ZONE]

button followed by the zone number. Repeat this procedure for each zone to be tested.

2. Press [TEST], then press [1].
3. Put the selected zone into alarm (pull the pull station, blow smoke into the smoke detector, etc.). The signal-circuit alarm device will pulse twice. After about 30 seconds, if the zone is still in alarm, smoke-detector power will automatically be removed for 4 seconds in an attempt to reset the alarm condition.
4. If, after the smoke power-up time (2 seconds plus any programmed additional time), the alarm condition is reset, the signal-circuit alarm device will pulse once.
5. Put the zone into trouble (open the circuit). The mini-sounder and trouble relay will pulse twice.
6. Repair the trouble condition. The trouble relay and mini-sounder will pulse once, indicating that the zone is repaired.
7. To exit Test #1, enable the zones that have been disabled, one zone at a time.

**NOTE 1:** In the Test #1 mode, those zones that have not been disabled will remain active. Should a real alarm condition occur, the test mode will be cancelled and the system will revert to normal operation, except that the disabled zone will still be in the disabled state until manually enabled.

**NOTE 2:** While Test #1 will check individual initiating devices, it does not provide a true overall system response to an alarm or trouble condition. For this reason, it will necessary to verify system operation (i.e., DD6000 or M6000 trips; bell activations and time-outs, etc.) by initiating the zone while it is enabled.

**Test #2 - Communicator Test.** This will test communicator operation by transmitting the Test-Timer Identification Number. Call the central station to notify them of the test.

To invoke Test #2, press [TEST], then press [2] to initiate the transmission. Call the central station to verify reception. (If Status Report has been programmed, a status report will be sent if there are any zones in alarm or trouble.)

The system will automatically revert to normal operation upon completion.

**Test #3 - System Test.** This will test the control-panel indicators. To invoke Test #3, press [TEST], then press [3]. All LEDs will flash as the mini-sounder pulses, and digits "1" through "8" will appear sequentially on the numeric display for about 4 minutes, or until [SILENCE] is pressed.

While the LEDs and numeric display will go out after about 4 minutes, the mini-sounder will continue to sound; press [SILENCE] to shut off the sounder and exit Test #3.

Test #4 - Fire-Drill Test. This will activate the signal circuits. To invoke Test #4, press [TEST], then press [4]. The alarm will sound until reset by pressing [SILENCE], which will restore normal operation. If a DD8000 Digital Communicator or an M6000 Polarity-Reversal Module is installed, neither will be activated.

#### CHANGES FROM THE PREVIOUS EDITION

The following changes were made to this edition:

- Page 4: SPECIFICATIONS, Initiating Loops: System Sensor Model 2300T added.
- Page 7: Smoke Detectors, Two-Wire Type: System Sensor Model 2300T added.



### 3. PROM PROGRAMMING

#### PROGRAMMING MATERIALS

**Subscriber PROM.** The preprogrammed DD496 PROM (integrated-circuit) supplied with the control panel has been programmed with the features needed for most local installations. Additional features and codes necessary for digital communication are programmed using a NAPCO PRO-410/410M Programmer. After programming, the PROM is plugged into the PROM socket on the control-panel circuit board.

**Glossary.** Detailed programming instructions are contained in the GLOSSARY & PROGRAMMING DATA section of this manual. Glossary entries are listed in alphanumeric order, not in order of PROM location; PROM locations follow entry where applicable.

**Programming Record Sheets.** Programming Record Sheets (PF156) similar to those that follow are completed when planning optional system features and communicator information for the particular installation. These sheets are used when programming the Subscriber PROM, and should be retained for future reference.

#### PROGRAMMING STEPS

1. If the DD6000 Digital Communicator is installed, contact the central station to confirm receiver format, data format, event codes, subscriber numbers and telephone number(s). Two receiver descriptions and telephone numbers, and up to 6 Subscriber Identification Numbers may be required.

**NOTE:** If the DD6000 communicator is *not* installed, do not program any reporting features or communicator transmission information, as a System-Trouble "5" indication may result.

2. Complete the Programming Record Sheet. Reference record sheets for MF6000-series control panels are furnished in the following pages. Select the desired features by circling the respective "location" boxes. Refer to the GLOSSARY for guidance in selecting "data" entries.
3. To program the Subscriber PROM, follow the instructions furnished with the PRO-410/410M Programmer. Note, however, the PAGE switch on the Programmer. Factory-programmed data are contained on PROM Page 1, programmable data on Page 0; thus the PAGE switch is normally set to [0]. It is not necessary to copy a NAPCO Master PROM onto the DD496 PROM supplied with the system. The DD496 PROM already contains the master information preprogrammed into it. Plug the preprogrammed DD496 PROM into the Programmer [SUBSCRIBER] PROM socket.
4. Program the data entries in the boxes on the Programming

Record Sheets into the respective PROM locations. The Programmer displays the entries numerically, but will display "0" for the number "10", and letters "b", "C", "d", "E", and "F" for the numbers "11" through "15", respectively. To program a "10", press [0]. To program "11" through "15", either press [b] through [F] respectively, or use the [PLUS] key to enter any two (or more) digits that add up to the desired entry.

Entry Total:	10	11	12	13	14	15
Display:	0	b	C	d	E	F

Thus, to program "13", enter either [d] or [8] [PLUS] [5], or [8] [PLUS] [4] [PLUS] [1], etc. Similarly, to *add* to an existing PROM location, *first press the [PLUS] key*, then the complementary digit, otherwise the digit entered will *replace* the digit in memory.

Refer to the PRO-410/410M instruction manual for further programming details.

5. Fill out the INSTALLATION RECORD label (LA609, supplied). Remove the protective paper covering the adhesive, and apply the label to the enclosure door (inside), just below the lock.



NAPCO PRO-410 Programmer

**MF6000-SERIES PROGRAMMING RECORD SHEET**

**NOTE: IF THE DD6000 IS NOT INSTALLED, DO NOT PROGRAM ANY REPORTING FEATURES.**

FEATURE	ALARM				TROUBLE				SYSTEM TROUBLE							
	ZONE								AC FAIL	WATER SUP	SIGNAL	GND FAULT	TELCO TROUBLE	DEVICE DSABL	LOW BAT	TEST TIMER
	1	2	3	4	1	2	3	4								
REPORT ON ALARM/TROUBLE	166	166	166	166	167	167	167	167	168	168	168	168	169	169	169	169
RESTORAL REPORT	170	170	170	170	171	171	171	171	172	172	172	172	173	173	173	173
WATERFLOW ZONE	178	178	178	178												
PRE-SIGNAL ALARM	180	180	180	180												
ALARM VERIFICATION	182	182	182	182												
INHIBIT SIGNAL-CIRCUIT ALARM	184	184	184	184												
INHIBIT TROUBLE RELAY					187	187	187	187	188	188	188	188	189	189	189	
INHIBIT AUXILIARY ALARM RELAY	190	190	190	190												



TOUCH-TONE <sup>(A)</sup> DIALING	194
TOUCH-TONE <sup>(A)</sup> /ROTARY BACKUP	194
(RESERVED)	194
(RESERVED)	194
POLARITY REVERSAL ALARM OPERATION	195
(RESERVED)	195
STATUS REPORTING	195
INHIBIT KEYPAD DIGIT BEEP	195
(RESERVED)	196
ENABLE R6000 OUTPUTS	196
INHIBIT KEYPAD ZONE/DEVICE BUTTONS	196
(RESERVED)	196
INHIBIT ZONE-TROUBLE RESOUND	197
INHIBIT SYSTEM-TROUBLE RESOUND	197
INHIBIT ZONE-ENABLE RESOUND	197
INHIBIT 24-HOUR TROUBLE REMINDER	197

TIME EXAMPLE CHART		
(seconds or minutes)		
TIME	1st BOX	2nd BOX
5	5	NONE
15	F	NONE
30	E	1
45	d	2
60	C	3

EXTERNAL SILENCE KEYSWITCH	
DON'T SHUT OFF SIGNAL CIRCUIT	215
SHUT OFF AUXILIARY ALARM RELAY	215
DON'T SHUT OFF TROUBLE RELAY	215

TEST TIMER	
OFFSET (hr)	198 199
WATERFLOW RETARD TIME (sec)	200 201
VERIFICATION POWER-OFF TIME*	202 203
ADDL. SMOKE-DET. POWER-UP TIME**	204 205

KEYPAD SILENCE BUTTON	
DON'T SHUT OFF SIGNAL CIRCUIT	217
SHUT OFF AUXILIARY ALARM RELAY	217
DON'T SHUT OFF TROUBLE RELAY	217

TIME-OUTS (min)	
PRE-SIGNAL ALARM DELAY	206 207
SIGNAL-CIRCUIT ALARM	208 209
TROUBLE RELAY	210 211
AUXILIARY ALARM RELAY	212 213

\* In 1/4-sec (quarter-seconds). For Alarm Verification, program E,2 (46) = 11.5 sec.  
 \*\*In 1/4-sec (quarter-seconds). Leave blank for 2 seconds.

CUSTOMER:	
ADDRESS:	
TELEPHONE:	
DATE INSTALLED:	
NOTES:	

**MF6000-SERIES PROGRAMMING RECORD SHEET**  
**Communicator Transmission Information**

ALARM/TROUBLE CODES	GROUP 1								GROUP 2							
	ALARM				TROUBLE				SYSTEM TROUBLE							
	ZONE								AC	WATER	SIGNAL	GN	TELCO	VOICE	LOW	TEST
	1	2	3	4	1	2	3	4	FAIL	SUPN	TROBLE	FAIL	TROBLE	DSAGL	BAT	TIMER
Single Digit	000	002	004	006	008	010	012	014	016	018	020	022	024	026	028	030
Extended or Two Digit	001	003	005	007	009	011	013	015	017	019	021	023	025	027	029	031
RESTORE CODES																
Single Digit	040	042	044	046	048	050	052	054	056	058	060	062	064	066	068	070
Extended or Two Digit	041	043	045	047	049	051	053	055	057	059	061	063	065	067	069	071

SUBSCRIBER I.D. NUMBERS

	Alarm/Restoral ID <sup>(1)</sup>								Test-Timer ID <sup>(2)</sup>				Status Code
	GROUP 1				GROUP 2								
Telephone 1	100	101	102	103	104	105	106	107	108	109	110	111	038
Telephone 2	132	133	134	135	136	137	138	139	140	141	142	143	(*) 039

	Format Rcvr Data	Dial-Tone Detection	Telephone Number															
Telephone 1	112 113	114	115	116	117	118	119	120	121	122	123	124	125	126	127	128	129	
			130	131														
Telephone 2	144 145	146	147	148	149	150	151	152	153	154	155	156	157	158	159	160	161	
			162	163														

ENTRY	RECEIVER FORMAT
Blank	ADEMCO, SILENT KNIGHT "SLOW"
1	SESCOA, VERTEX, DCI, FRANKLIN <sup>(2)</sup>
2	RADIONICS "FAST" <sup>(2)</sup>
3	SILENT KNIGHT "FAST"
4	RADIONICS, DCI, FRANKLIN "SLOW" <sup>(2)</sup>
5	(RESERVED)
6	(RESERVED)
7	RADIONICS BFOK <sup>(2)</sup>
8	FOR 2300Hz HANDSHAKE, ADD AN "8" TO THIS LOCATION

ENTRY	DATA FORMAT
Blank	EXTENDED OR SINGLE DIGIT
1	SINGLE DIGIT
2	TWO DIGIT (OR 4/2)
4	SUM CHECK

**NOTES:**

(1) GROUP-2 CODES MUST BE ENTERED, EVEN IF THEY ARE THE SAME AS GROUP-1 CODES.

(2) MUST BE PROGRAMMED FOR TEST TIMER OPERATION.

(3) THESE FORMATS TYPICALLY USE A 2300Hz HANDSHAKE; ADD AN "8" TO THIS ENTRY.

(4) TWO-DIGIT FORMAT ONLY.

## GLOSSARY & PROGRAMMING INFORMATION

### Ac-Failure Reporting (Location 168, 172)

To select Ac-Failure Reporting, program a "1" in location 168 and a trouble code in locations 016 and 017. Should an ac power failure occur, a report will be sent to the central station after 8 hours. If a low-battery condition is detected during the 8-hour delay, Ac Failure (as well as Low Battery) will report immediately. Programming a "1" in location 172 will cause a restoral report to be sent when power is restored. Enter a restore code in locations 056 and 057.

### Additional Smoke-Detector Power-Up Time (Locations 204-205)

This feature prevents the control panel from going back into alarm after power is removed and reapplied during reset. A 2-second delay (for most smoke detectors) prevents another alarm during the power-up. If a smoke detector takes longer than 2 seconds to become active after power-up, program additional time in locations 204-205 (see Time Selection). U.L. requirements specify that no additional power-up time be programmed if alarm verification is selected.

### Alarm Verification (Location 182)

Use this feature on zones with smoke detectors only. When selected, an alarm on a verification zone will first cause all zones to power down for 11.5 seconds (program "E" in location 202; a "2" in location 203). After this time, power is restored and the 2-second smoke-detector power-up time is started. Thereafter, the zone will be active again. This represents a total processing delay of 15 seconds from the time the alarm is first detected. If an alarm condition still exists at this time, or reoccurs within 2 to 3 minutes, an alarm will be initiated. U.L. requires that no additional smoke detector power-up time be programmed in locations 204-205 to ensure that other zones without alarm verification will become active again within 15 seconds.

### Anti-Jam Time

If the communicator does not detect a dial tone within 7 seconds, the Anti-Jam feature will be activated. That is, the communicator will go off line for a 16-second anti-jam interval in order to free the telephone circuit from incoming calls. then make another 7-second attempt at dial-tone detection. If still unsuccessful, the communicator will again go off line for 16 seconds, wait another 7 seconds, then proceed to dial anyway.

To test the Anti-Jam feature, call the alarm phone line from a different phone line, then activate an alarm. The incoming call

should be disconnected by the control panel.

**Auxiliary Alarm Relay** See Inhibit Auxiliary Alarm Relay

Also see Time Selection, locations 212-213.

**Backup Reporting**

If the communicator does not reach the first telephone number after two attempts, three attempts will be made to reach the second telephone number. Enter Subscriber Identification Numbers for Telephone 2 (locations 132-143) and other information required for Telephone 2 (locations 144-163).

**NOTE:** Subscriber Identification Numbers for both Telephones 1 and 2 *must* be entered, even if they are the same. U.L. installations require that two *different* phone numbers be programmed.

**Daily Reminder** See Inhibit 24-Hour Reminder

**Data Format** (Locations 113, 145)

Consult the central station to find out which of the following formats to use.

**Extended Format.** Extended-format reporting allows the communicator to transmit an extra digit to the central station. This extra digit is generally used to report the user or the zone on which the event occurred.

**Example.** An installation uses the following programmed transmission information: Subscriber Identification Number is "678"; Extended Format Trouble Code is "F3" (Trouble, Zone 3). If Zone 3 experiences a trouble condition, the communicator will transmit

678F - Subscriber "678" has a trouble.  
FFF3 - Trouble Zone 3.

Extended Format may be used with most central-station receivers. Most receivers capable of recognizing multiple reporting will also recognize Extended Format. The central station will indicate the event codes to be programmed. Extended Format does *not* require any programming in locations 113 and 145. To use Extended Format, follow Steps 2 through 5 of Two-Digit Event-Code Format later in this section.

**Single-Digit Event Code Format.** If the receiver cannot accept extended reporting,

1. Program a "1" in location 113 (and 145 for a second telephone number, if used). See Backup Reporting.

2. Enter the first digit for any Alarm/Trouble Code and Restore Code.

**NOTE:** If it is desired to have a Single-Digit Event Code for one telephone number and Extended Format for the other, program both digits for all event codes. Follow Steps 2 through 5 of Two-Digit Event Code Format, which follows. The telephone number with a "1" in location 113 (or 145) will transmit only the first digit. The other telephone number will use both digits. (Single-Digit Format will override Two-Digit Format in Location 113 or 145.)

**Two-Digit Event Code Format.** Some central-station receivers require that a two-digit code be sent in each report.

*Example.* In a certain installation, the Alarm Subscriber Number is "1234"; a fire alarm occurs on Zone 1 (Alarm Code "31"). The communicator will send "1234 31".

To use Two-Digit Event Code Format,

1. Program a "2" in location 113 (145 for a second telephone number, if used). See Backup Reporting.
2. Enter an Alarm/Trouble Code (locations 000-031) for each zone or condition to report on alarm (see Report on Alarm) or for a Status Report (locations 038-039) as follows:
  - a. Enter the first digit of the Alarm/Trouble Code. (This digit may be used to indicate alarm type.)
  - b. Enter the second digit of the Alarm/Trouble Code. (This digit may be used to indicate the zone.)
3. Repeat Step 2 to enter Restore Codes (locations 040-069) for each zone/trouble selected for Restoral Report (see Restoral Report).

**NOTE:** Single-Digit Format will override Two-Digit Format in location 113 or 145.

**Sum-Check Format.** Sum Check is a sophisticated data format used to enhance the speed and check the accuracy of the received transmission. This format should be preferred whenever the central station is capable of receiving it.

After transmitting the Subscriber Identification Number and the event code, the communicator sends a verifying digit that is the sum of both. The receiver compares the verifying digit with the sum of the other two numbers to check transmission accuracy. To select Sum Check, program a "4" in location 113 (or 145 for a second telephone number, if used).

### Dial-Tone Detection (Locations 114, 146)

At least one Dial-Tone Detection entry is required for each telephone number used to ensure that a dial tone is present before the communicator dials.

When an "E" ([8] [PLUS] [6]) is programmed before the first digit of an outside telephone number, the communicator dial-tone detection circuit is set to detect the standard 440Hz dial tone. The "E" is generally entered in location 114 for Telephone 1 and location 146 for Telephone 2, if used.

### Enable R6000 Outputs (Location 196)

Program a "2" in Location 196 to activate an installed R6000 Remote Interface Module. Refer to Installation Instructions WI467 for R6000 specifications and mounting information.

### External Silence Keyswitch (Location 215)

A knockout is provided on the right side of the enclosure for an external silence keyswitch to preclude the need for unauthorized personnel to open the enclosure door. This switch will normally shut off the mini-sounder indication, the signal circuit, and the trouble relay. If it is desired *not* to shut off the signal circuit, to shut off the alarm relay, or *not* to shut off the trouble relay, program the corresponding entries in location 215. Note that the External Silence Keyswitch operates independently of the keypad silence switch. See keypad [SILENCE] button. If the External Silence Keyswitch is to be remotely mounted, it must be connected to the control panel using conduit, and must be located in the same room as, and within 50 feet of, the control panel.

### Ground Fault

Should a short to ground occur on any zone (1-4), either signal circuit, or the Sprinkler Supervisory Loop, a ground-fault condition will be indicated by System Trouble "4". See System Trouble.

### Inhibit Auxiliary Alarm Relay (Location 190)

In normal operation, any alarm on Zones 1-4 will activate the auxiliary alarm relay. Any zone may be prevented from activating the auxiliary alarm relay by programming location 190.

### Inhibit Keypad Digit Beep (Location 195)

To disable the momentary tone that normally sounds when a key is pressed, program an "8" in location 195.

### Inhibit Keypad Zone/Device Buttons (Location 196)

A "4" in location 196 will deactivate the following four buttons: DISABLE A ZONE; ENABLE A ZONE; DISABLE A DEVICE; ENABLE A DEVICE.



**Inhibit Signal-Circuit Alarm** (Location 184)

Two supervised signal-circuit alarm outputs are available. Normally, any alarm on Zones 1-4 will activate the signal-circuit alarm relay (thus both outputs) unless inhibited by programming in location 184.

**Inhibit System-Trouble Resound** (Location 197)

When a system trouble occurs or a device is disabled, the mini-sounder will beep intermittently and the SYSTEM TROUBLE LED will flash. After silencing the mini-sounder with the [SILENCE] button, the LED will come on steadily and the numerical display will go out. If the trouble is repaired or the device is enabled, the LED will flash and the mini-sounder will come on steadily (resound). To disable this trouble resound, program a "2" in location 197.

When selected, after pressing the [SILENCE] button, the SYSTEM TROUBLE LED will go out when all the troubles are repaired and when all the devices are enabled.

**Inhibit Trouble Relay** (Locations 187-189)

Normally, a zone trouble, system trouble, or device disable will activate the trouble relay. Any may be prevented from activating the trouble relay by programming locations 187-189. When a zone is disabled, the trouble relay will always activate, even if "Inhibit Trouble Relay" has been programmed for a zone trouble.

**Inhibit Zone-Enable Resound** (Location 197)

When a zone is disabled, the mini-sounder will beep intermittently and the ZONE DISABLED LED will flash. After silencing the mini-sounder with the [SILENCE] button, the LED will come on steadily and the numeric display will go out. If the zone is enabled, the LED will flash and the mini-sounder will come on steadily (resound). To disable this resound, program a "4" in location 197.

When selected, after pressing the [SILENCE] button, the ZONE DISABLED LED will go out when all zones are enabled.

**Inhibit Zone-Trouble Resound** (Location 197)

When a zone trouble occurs, the mini-sounder will beep intermittently and the ZONE TROUBLE LED will flash. After silencing the mini-sounder with the [SILENCE] button, the LED will come on steadily and the numerical display will go out. If the trouble is repaired, the LED will flash and the mini-sounder will come on steadily (resound). To disable this trouble resound, program a "1" in location 197.

When selected, after pressing the [SILENCE] button, the ZONE TROUBLE LED will go out when all troubles are repaired.

Inhibit 24-Hour Trouble Reminder (Location 197)

A zone or system trouble indication will normally recur every 24 hours if the trouble or disable still exists after silencing. Programming an "8" in location 197 will inhibit this feature.

Keypad Silence Button (Location 217)

In normal operation, the [SILENCE] button on the keypad will silence the mini-sounder, the signal circuit, and the trouble relay. If it is desired *not* to silence the signal circuit, to shut off the alarm relay, or *not* to shut off the trouble relay, program the corresponding entry on the programming record sheet (PF156).

Also see External Silence Keyswitch.

Low Battery (Location 169, 173)

A low-battery alarm will signal when the battery terminal voltage drops to 21Vdc in the MFA6024, or 11Vdc in the MFA6012. A low-battery condition may report to a central station by programming a "4" in location 169.

M6000 See Polarity-Reversal Alarm

No Ac See Ac-Failure Reporting

Polarity-Reversal Alarm (Location 195)

The NAPCO M6000 Polarity-Reversal Module allows the control panel to be monitored by a central station through leased lines. U.L. Remote Station or Auxiliary Protected Premises installations require this module. If installing the M6000, program a "1" in location 195. There is no need to program Report on Alarm for any zone.

On alarm, the module will reverse normal line-voltage polarity. This module also has provisions for local-energy (series) municipal box connection. For installation details, refer to the instructions (WI385) furnished with the module.

NOTE 1: Disable Device #4 (Telephone Line) has no effect on a polarity-reversal alarm.

NOTE 2: Do not program Location 195 if using an M278 Line Reversal Module. The M278 is activated by the alarm relay or trouble relay and does not have a municipal box connection. Refer to the instructions furnished with the M278 (WI205).

Pre-Signal Alarm (Location 180)  
Pre-Signal Alarm Delay (Locations 206, 207)

Where approved by the authority having jurisdiction, an alarm sounding device may be installed in department offices, engine rooms, fire brigade stations, or other central locations, with the provisions whereby authorized persons may subsequently sound a general alarm. Zones programmed for pre-signal alarm in location 180 will not activate the signal-circuit alarm, but will activate the auxiliary alarm relay to which the pre-signal alarm device is connected.

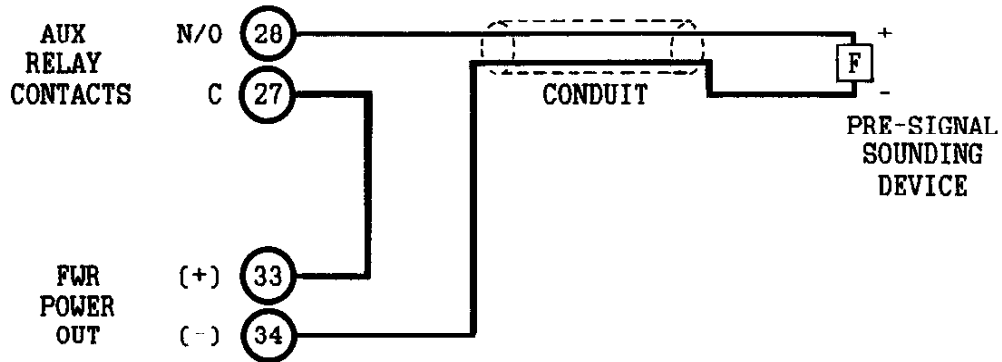

**NOTE:** U.L. requires that the pre-signal sounding device be located in the same room as the control unit, and that rigid conduit, or equivalent protection, be used between the control unit and the device.

If a zone is programmed for pre-signal, a Pre-Signal Alarm Delay time must be entered in locations 206-207 (otherwise, a general alarm will sound instantly). The pre-signal alarm will default to a general alarm after the delay time programmed. If the pre-signal is not to automatically default to a general alarm, program Inhibit Signal-Circuit Alarm for that zone. A general alarm must then be sounded manually from another zone (without pre-signal).

Receiver Format (Locations 112, 144)

The communicator can be programmed to transmit to any standard central-station receiver. A receiver format must be entered for each telephone number, but a different format may be assigned to each. Call the central station for each telephone number used to confirm the type of receiver in use. Select the receiver format entry for each telephone number from the following table.

ENTRY	RECEIVER FORMAT	DATA FREQ.	DUTY CYCLE (ON/OFF)	INTERDIGIT TIME
(blank)	Adamsco, Silent Knight "slow"	1900Hz	00/40mS	000mS
1	Sescoa, Vertex, DCI, Franklin	1800	30/20	800
2	Radionics "fast"	1800	13/12	400
3	Silent Knight "fast"	1800	40/30	580
4	Radionics, DCI, Franklin "slow"	1800	60/40	600
5	Reserved			
6	Reserved			
7	Radionics BFSK			
8	Add "8" for 2300Hz handshake; Do not add if 1400Hz handshake.			

Program the receiver-format entry in location 112 for Telephone 1 and location 144 for Telephone 2.

#### Report on Alarm/Trouble (Locations 166-169)

Violation of a zone or trouble selected to Report on Alarm/Trouble will cause the communicator to transmit the code selected for that zone or trouble to the central station. Enter Alarm/Trouble Codes (locations 000-031) for each zone to report, even if identical codes are used for different zones. Zone disable will use the respective zone trouble codes.

**NOTE:** U.L. requires that all alarms/troubles report to a central station. The central station must be able to distinguish between a fire alarm, fire trouble, and sprinkler supervisory. System troubles (other than sprinkler supervisory) may share a common code.

#### Restoral Report (Locations 170-173)

When selecting a Restoral Report, (a) Subscriber Alarm/Restoral Identification Numbers *must* be programmed for Telephone 1 (locations 100-107) and Telephone 2 (locations 132-139), if used; and (b) Restore Codes (locations 040-069) *must* be entered for each zone selected to report a restoral. The communicator will transmit a restoral report to the central station after the zone or trouble is reset.

**NOTE:** U.L. requires that all alarm restorals and trouble restorals report to the central station. The central station must be able to distinguish between fire alarm restorals, fire trouble restorals, and waterflow supervisory restorals. System trouble restorals (other than supervisory restorals) may share a common code.

Signal-Circuit Alarm See Inhibit Signal-Circuit Alarm

Also see Time Selection, locations 208-209.

Status Reporting (Location 195)

When a "4" is programmed in location 195 and a test timer is programmed to report (location 169), a Status report will be transmitted along with the test timer report if a zone is disabled, or if a zone trouble or fire alarm condition exists. A status code must be programmed in locations 038-039 (location 039 is used only for 4/2 reporting).

A Status Report will consist of the Test-Timer ID followed by the Test-Timer Alarm Code; the Test Timer ID followed by the Status Code; then an expanded Status Code followed by the first digit of the trouble code (or the second digit if a two-digit code is used). For example, a Status Report might look like:

789 8	Test-Timer ID / Alarm Code
789 F	Test-Timer ID / Status Code
FFF 4	Trouble Zone 4

Subscriber Identification Numbers (Locations 100-111; 132-143)

Different Subscriber Identification Numbers may be used by the central station to distinguish Zone Alarm/Trouble and Restoral Reports (Group 1, locations 100-103) from System Trouble and Restoral Reports (Group 2, locations 104-107). Test-Timer Report may also have its own Subscriber Identification Number (locations 108-111). Both groups and the Test Timer ID must be programmed, even if all use the same number. See Report on Alarm; Restoral Report.

Furthermore, different Subscriber Identification Numbers may be required for Telephone Number 2 (locations 132-143). As above, both groups and the Test Timer ID must be programmed, even if all use the same number. See Backup Reporting.

NOTE: Starting at the left-most location, enter at least 3 digits for each Subscriber Identification Number, even if the first two are zeros. A fourth digit is available for those receivers capable of recognizing 4-digit subscriber codes.

Supervisory Loop

The Supervisory Loop is normally used for sprinkler supervisory devices, such as water shutoff valves and devices that monitor tank water level, air and water pressure, water temperature or similar conditions to ensure the normal operation of an automatic sprinkler system. This loop requires normally-open contacts with an end-of-line resistor. A System Trouble "2" will display if the loop is opened; or a "3" (with LED on at upper left corner of

board) if the loop is shorted. A Ground Fault (System Trouble "4") will also be displayed if either terminal is grounded.

Telephone Numbers (Locations 115-131; 147-163)

To report to a central station, Telephone Number 1 (locations 115-131) and Telephone Number 2 (locations 147-163) must be programmed. UL requires a different telephone number for Telephone Number 2.

Telephone Number 1 will be preceded by at least one Dial-Tone Detection entry ("E" in location 114) to ensure that the communicator detects a dial tone to access a telephone line before dialing. (See Dial-Tone Detection.)

The extra locations within the Telephone Number group may be used to correct telephone-number programming errors. To correct an error, enter an "F" ([8] [PLUS] [7]) in the location with the incorrect digit and enter the correct digit in the following location. The "F" will be ignored by the communicator when dialing. (This is true for Telephone Number 2 (locations 147-163) as well.)

Test Timer (Locations 030, 031; 169; 198, 199)

UL requires test-timer reports. When an "8" is programmed into location 169, a daily test report will be transmitted to the central station from the time the control panel is powered up. The respective Alarm Code is programmed into locations 030-031. Enter Subscriber ID Numbers in locations 108-111 for Telephone Number 1, and locations 140-143 for Telephone Number 2. Also program an Alarm Code in locations 030-031. Do not program a Restore for Test Timer.

To have a test-timer report occur at a time other than power-up, an offset time, in hours, may be programmed in locations 198-199. See Time Selection. Thus, to delay a report two hours from power-up, for example, program a "2" in location 198. Test-timer reports will occur daily at that time thereafter.

Time-Out (Locations 206-213)

Time-Out specifies the length of time that an output or delay will remain active. See Time Selection. Note that an internal timer can add up to 1 minute to the programmed time-out. (See COMPLETING THE INSTALLATION for instructions on filling in the AUTOMATIC TIME-OUT section of the front-door faceplate card.)

**NOTE:** In the State of California, do not program a time-out for fire alarms.

**Time Selection** (Also see Programming Sheet)

The following times are programmable:

Time	Locations	Units	Max. Programmable Time
Timer Offset	198, 199	hours	24 hrs
Waterflow Retard Time	200, 201	seconds	120 sec (see Note 1).
Verification Power-Off Time	202, 203	1/4-seconds	11.5 sec (see Note 2).
Adj. Smoke-Detector Power-Up Time	204, 205	1/4-seconds	20 sec (see Notes 2&3).
Pre-Signal Alarm Delay	206, 207	minutes	4 hrs, 15 min (255 min).
Signal-Circuit Alarm	208, 209	minutes	254 min (see Notes 4&5).
Trouble Relay	210, 211	minutes	254 min (see Note 5).
Auxiliary Alarm Relay	212, 213	minutes	254 min (see Note 5).

**NOTES:**

- Do not program for more than 120 seconds. If using waterflow initiating devices having mechanical retard, U.L. requires that these locations be left blank to prevent programming additional retard time.
- If using Alarm Verification, program an "E" in location 202 and a "2" in location 203. Do not program additional time in locations 204, 205.
- When left blank, Smoke-Detector Power-Up Time will be 2 seconds. Do not program more than 28 additional seconds.
- In the State of California, do not program a time-out for fire alarms.
- If both locations are left blank, the relay will remain active until manually silenced. If both locations are programmed "F", there will be no output.

The Time Selector Chart on the Programming Sheet shows examples only, in quarter-seconds (1 second equals 4 quarter-seconds), seconds, minutes, or hours. Actually, any time up to those shown in the foregoing table may be programmed. Note that each of the above times is programmed in two locations. The first location has a time factor of 1, the second a time factor of 16.

1st BOX	2nd BOX
tx1	tx16

Time (t):	0	1	2	3	4	5	6	7	8	9	10	11	12	13	14	15
Entry:	*	1	2	3	4	5	6	7	8	9	0	b	c	d	e	f

\*Blank.

**NOTE:** If both programming locations are left blank, refer to the notes in the foregoing table for feature time-out.

To select a time up to 15 hours, 15 minutes, 15 seconds, or 15 quarter-seconds (3.75 seconds), program the respective entry into the first box only; do not program the second box. To select a time greater than 15 hours, 15 minutes, seconds, or 15 quarter-seconds, program both boxes as follows:

- For the feature selected, choose an appropriate time in hours, minutes, seconds, or quarter-seconds (not hours and minutes; minutes and seconds, etc.).
- Divide the time chosen by 16. Enter the *quotient* in the 2nd

BOX and the remainder in the 1st BOX. (Remember that a remainder of 10 is made as a "0" entry on the PRO-410/410M.)

3. Check entries by adding the contents of the 1st BOX to 16 times the contents of the 2nd BOX.

*Example 1.* Program a Signal-Circuit Alarm Time-Out of 5 minutes.

1. Signal-Circuit Alarm Time-Out (locations 208, 209) is in minutes.
2. Since the selected time is less than 15 minutes, simply program the entry ("5") in the first box (location 208) only. Do not program location 209.

208	209
5	

entry less than 15          leave blank

3. Check entries (remember, a blank entry = "0"):  $5 + 16(0) = 5$ .

*Example 2.* Program Smoke-Detector Power-Up Time for an additional 4 seconds.

1. Additional Smoke-Detector Power-Up Time (locations 204-205) is in units of quarter-seconds; 4 seconds = 16 quarter-seconds.
2. Divide by 16:  $16/16 = 1$  (quotient) + 0 (remainder). Enter the quotient in the 2nd BOX and the remainder (blank entry for "0") in the 1st BOX:

204	205
	1

remainder          quotient  
(blank for "0")

3. Check entries (remember, a blank entry = "0"):  $0 + 16(1) = 16$ .

Timer Offset See Test Timer; Time Selection

Touch-Tone Dialing (Location 194)

Touch-Tone/Rotary Backup (Location 194)

Select Touch-Tone Dialing only when the subscriber has Touch-Tone service. Touch-Tone dialing is faster than rotary dialing, but not always as reliable.

For the communicator to use Touch-Tone on all dial attempts, add a "1" to location 194. To use Touch-Tone on the first attempt



with subsequent rotary dial attempts, add a "2" to location 194. If neither is selected, the communicator will rotary dial. Touch-Tone Dialing will override Touch-Tone/Rotary Backup if both are selected.

Trouble Relay See Inhibit Trouble Relay.  
Also see Time Selection.

Trouble Reminder See Inhibit 24-Hour Trouble Reminder.

Verification Power-Off Time See Alarm Verification.

Waterflow Retard Time (Locations 200, 201)

An alarm on a zone programmed for Waterflow can be delayed up to 120 seconds to prevent momentary surges from causing a false alarm by programming a time in locations 200 and 201. If using waterflow initiating devices having a mechanical retard, U.L. requires that locations 200 and 201 be left blank to prevent programming additional retard time. See Time Selection.

Waterflow Zone (Location 178)

A Waterflow Zone is one that monitors sprinkler-system waterflow and is activated by an initiating device approved for that purpose. An alarm on a zone that has been programmed as a Waterflow Zone will prevent the signal circuit from being silenced by the [SILENCE] button or from timing out. The alarm will only be silenced if the [RESET] button is pressed while the alarm condition no longer exists.

**FOR SALES, SERVICE, OR TECHNICAL HELP, CALL TOLL FREE:**

**(800) 645-9445**

## 4. INSTALLATION

Because fire alarm control systems require different installation methods than those used in burglar alarm systems and are subject to more stringent inspection procedures, it is urged that you read this section carefully before proceeding.

Be sure you know the authority having jurisdiction governing the installation. The National Fire Protection Association (NFPA, Batterymarch Park, Quincy, MA 02269), which publishes guidelines for installation, calls this office the AHJ. In some states, the AHJ is required by law to review blueprints of the system before installation.

### MOUNTING

Choose a mounting location accessible to a cold-water-pipe ground ideally no further away than 10 feet, and telephone lines if the communicator option is selected. The enclosure may be recessed into a wall. (The cabinet door is removable. Slide it up and off when mounting the enclosure; replace it when wiring to have the wiring diagram at hand.)

Place the control panel at a convenient viewing height and mark the mounting holes. Remove appropriate knockouts for cables. Many jurisdictions require that wires to the control panel that are within 7 feet of the floor be protected by conduit. Check local codes. Should questions arise, always ask the authority having jurisdiction.

### GROUNDING

Connect the control-panel grounding screw to a metal cold-water pipe. Do not use a gas pipe, plastic pipe or ac ground connections. Use at least 16-gauge wire. Make the run as short and direct as possible, without any sharp bends in the wire.

### SYSTEM COMPONENTS

**Manual Pull Stations.** While not specified by NFPA guidelines, the use of dual-action manual pull stations is strongly preferred over single-action devices to reduce the possibility of accidental false alarms.

**Smoke and Heat Detectors.** Select compatible smoke detectors from the list in Section 1 (see **RECOMMENDED U.L.-LISTED DEVICES**). Smoke detectors are electronic devices and have an operating temperature range of 32 to 120 degrees F. Do not locate these sensors where temperatures may exceed these extremes. Similarly, heat detectors, which have a greater operating range, should not be located where they may be subject to a rapid change in temper-

ature. Do not install either type of sensor in a corner on a wall or ceiling, or within three feet of a duct. Refer to NFPA National Fire Codes 72E and 74 for guidelines in sensor placement.

**NOTE:** The use of heat detectors without smoke detectors is not recommended!

**Warning Devices.** Choose suitable warning devices from the list in Section 1 (see **RECOMMENDED U.L.-LISTED DEVICES**). Anticipate the noise and activity levels of the environment in the selection and placement of the device. NFPA guidelines specify noise levels for sounding devices in certain applications under various conditions. Strobes may be required in high-ambient-noise-level areas and/or where hearing-impaired persons may be present.

**WIRING (Refer to WIRING DIAGRAMS.)**

*Important:* The Wiring Diagrams summarize the required wiring information. Study them carefully; they contain certain valuable information not available elsewhere in this manual.

*All wiring must conform to local and NFPA codes.* Fire codes specify what type of wire must be used. Do not use burglar-alarm wire -- it will not pass inspection! Ac power connections to the control panel must be made to a 24-hour continuously-active ac line; do not connect to a switched outlet! Splice the ac line to the power transformer primary leads using insulated crimp connectors, wire nuts, etc.

Do not use wire thinner than #18AWG (the higher the number, the thinner the wire). The following charts may be used as guides in determining maximum wiring distances for parallel-connected sounding devices, but bear in mind that local wiring codes must prevail.

Number of Devices	#18* AWG	#16* AWG	#14 AWG	#12 AWG	#10 AWG	Maximum Resistance
1	2350'	3750'	6000'	8500'	15000'	30 ohms
2	1180	1860	3000	4250	7500	15
5	470	750	1200	1900	3000	6.0
10	235	375	600	850	1500	3.0
15	156	250	400	570	1000	2.0
20	118	186	300	425	750	1.5



\*May be permitted in multiconductor cables only.

**Table 3. Maximum distances for paralleled 24Vdc vibrating bells and horns, per signal circuit.**

**Battery Installation.** Remove ac power before installing the batteries.

Following are recommended stacking and wiring configurations for NAPCO RBAT-6 batteries (12V/6AH) and RBAT-H1 harnesses that will achieve most of the battery capacities shown in Tables 1 and 2

(see SPECIFICATIONS) when more than one 6AH battery is needed. Position the batteries inside the enclosure as shown. Assemble the respective battery harness as shown (if required). When connecting the harness to the battery stack, polarity *must* be observed. That is, a red lead must be connected to any unused positive (+) terminal; a black lead must be connected to any unused negative (-) terminal.

NOTE.  positive (+) terminal,  negative (-) terminal.

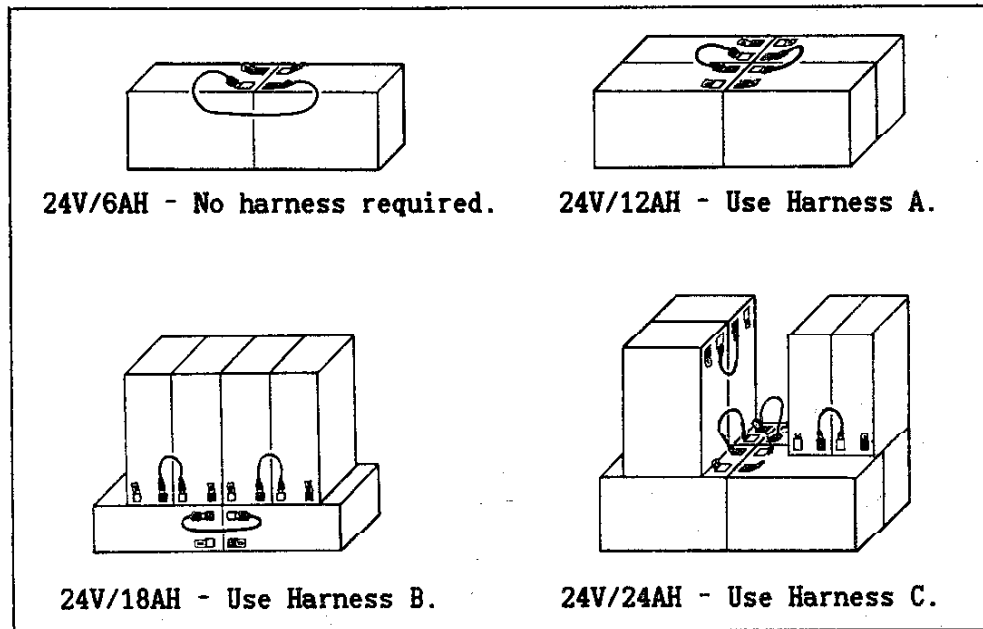

24-Volt Battery Stacking Configurations.

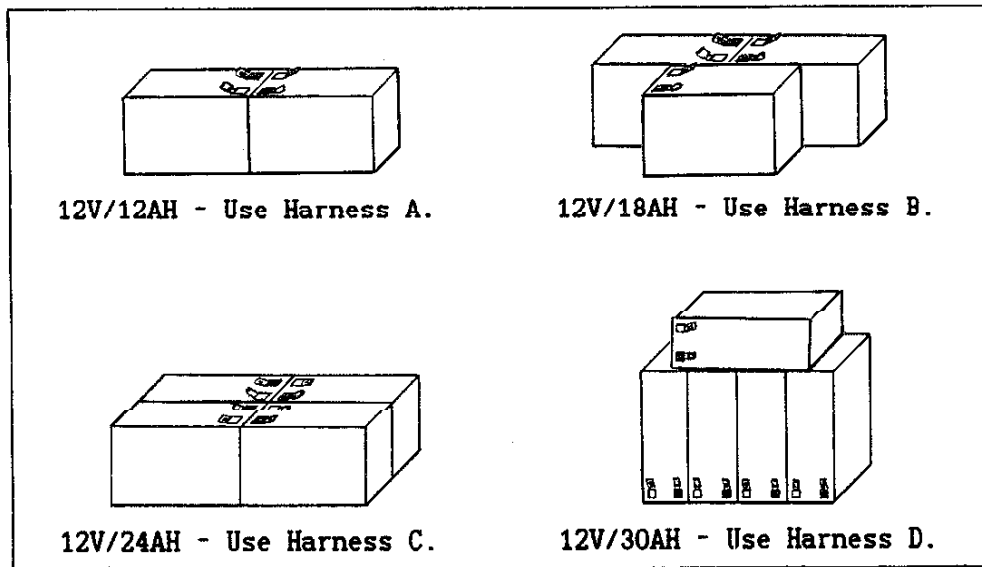

12-Volt Battery Stacking Configurations.

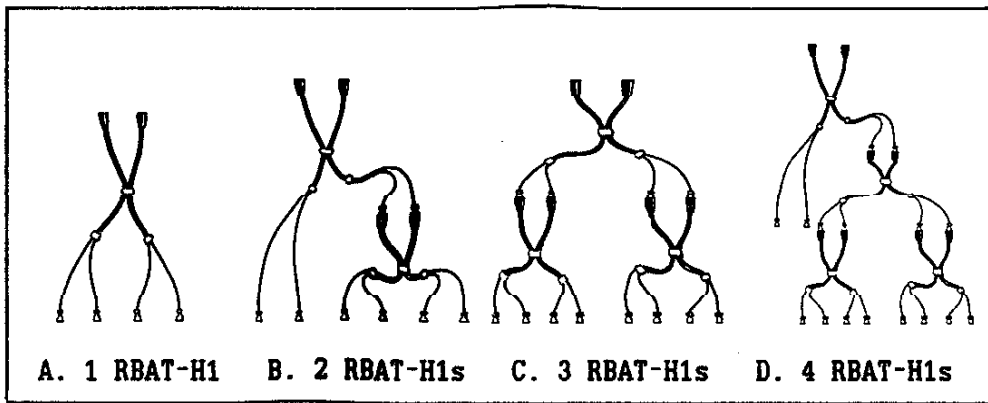

Battery Wiring Harnesses.

**Multipanel Systems.** Large installations may require more than four zones. This may be accomplished through the use of multiple panels. The following diagram shows how up to four subpanels may be wired to a main control panel to provide up to 16 zones.

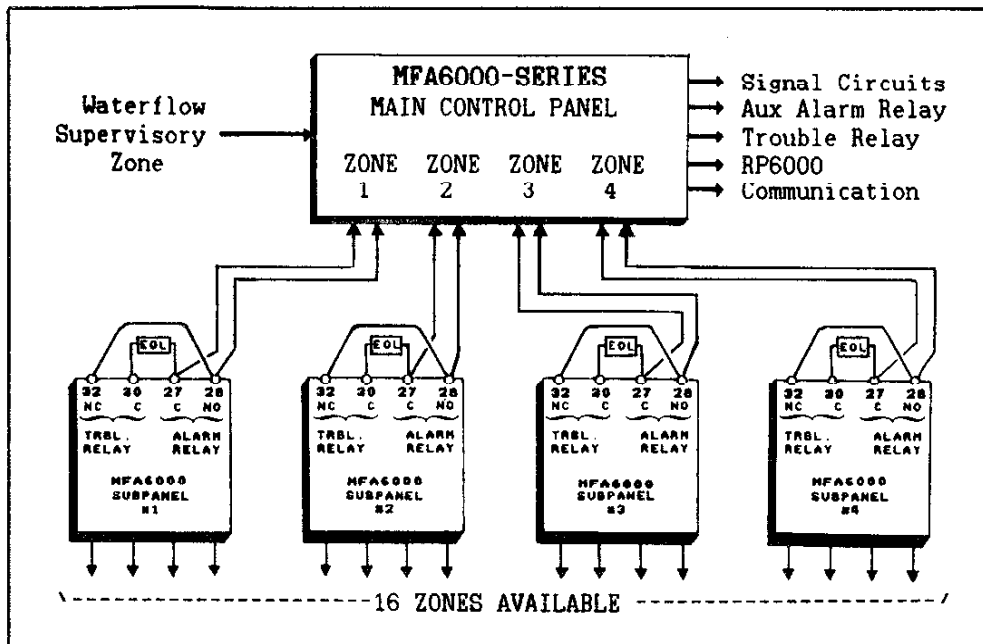

The end-of-line resistors for Zones 1-4 of the main control panel are installed across the normally-open auxiliary alarm relay contacts of the respective subpanel. The normally-closed contacts of the trouble relay are connected in series with each auxiliary alarm relay. If a trouble condition is detected by any subpanel, the trouble relay contacts will open, causing a zone trouble in the main panel. If an alarm is detected by any subpanel, the auxiliary alarm relay contacts will close, causing an alarm in the main panel. Note that the Waterflow Supervisory Zone is connected directly to the main panel. Main outputs, such as evacuation signals, are connected to the main panel. Communicator modules (DD6000, M6000, M278) are installed into the main panel. (If the DD6000 Digital Communicator is installed, alarm codes must be programmed so that the central station can distinguish between fire alarm and restore; fire trouble and restore; supervisory trouble and restore; and system trouble.)

**COMPLETING THE INSTALLATION**

After wiring has been completed, test the system as described in Section 2. (See TESTING THE SYSTEM) *Test each device and each system function!* Check the system from both ac power and standby battery power. Check communicator options, if selected. Failure to pass inspection will result in delays and additional expenses. Failure to conform to codes can result in legal liability.

Fill out pertinent information on the INSTALLATION RECORD label (LA609, supplied). Remove the protective paper backing and affix the label inside the enclosure door, in the lower-left corner.

Fill out all applicable information on the front-door faceplate card. When entering AUTOMATIC TIME-OUT, note that an internal timer can add up to 1 minute to the programmed time-out. Therefore, U.L. requires that a 1-minute time-out range be given. To do this, simply write in the programmed time-out as the low-end value, and add 1 minute to that number as the high-end value. For example, if Signal Circuit Time-Out is programmed for 5 minutes (low-end value), add "1" for the high-end value (6 minutes) and write in

**AUTOMATIC TIME-OUT IS 5 to 6 MINUTES.**

Insert the completed faceplate card behind the window in the front panel. Remove the metal brace from its plastic bag and place it behind the card, aligning the notches in the brace so that they engage the hooks in the front panel. Secure the card in place by bending over the 7 retainer tabs.

MFA-6000 SERIES INSTALLATION RECORD									
PRESIGNAL ALARM DELAY	Min								
SIGNAL CIRCUIT TIME OUT	Min								
TROUBLE RELAY TIME OUT	Min								
AUX ALARM RELAY TIME OUT	Min								
WATERFLOW RETARD	Sec								
TOTAL SMOKE RESET	Sec								
ZONE/EVENT	DEVICE/DESCRIPTION								
ZONE 1									
ZONE 2									
ZONE 3									
ZONE 4									
NO AC									
SUPV									
SIG CRT									
SND_FAULT									
TELCO									
DISABLE									
LOW BATT									
TEST TIMER									
LOCAL SERVICE REP	TEL #	ADDRESS							
NOTES									

**INSTALLATION RECORD label (above); front-door faceplate card at right.**

ZONE	AREA
1	
2	
3	
4	

**BASIC OPERATING INSTRUCTIONS FOR THE MFA-6000 SERIES FIRE CONTROL PANEL**

**STANDBY**  
Only the green AC light will be lit when no trouble or alarm exists.

**ALARM**  
Signal Devices (alarm bells, etc.) will sound, the red Alarm light will flash and the number of the zone in alarm will be displayed.

**AUTOMATIC TIME-OUT IS \_\_\_\_\_ MINUTES.**

**SILENCING AN ALARM**  
Press the Silence Button to silence the signal device(s). Any subsequent alarms will cause the signals to sound again.

**ALARM RESET**  
Reset the initiating device (reset pull station, clear smoke from detector, etc.); Press the Reset button. After a short delay, the red Alarm light will go out.

**ALARM TEST**  
Operate an initiating device. Signals will sound, the red Alarm light will flash and the number of the zone in alarm will be displayed.

**TROUBLE**

Zone trouble: Call for service if either trouble light is on or flashing. Yellow Zone Trouble light will flash. Zone number of zone in trouble will be displayed. Trouble sounder will pulse steadily. Press the Silence button to stop sounder.

System trouble: Yellow System Trouble light will flash. Number that is displayed indicates type of trouble. Trouble sounder will pulse steadily. Press the Silence button to stop sounder.

AC power light: If green AC Light is off, AC power is low or lost. Check for power line problem.

**LOCAL SERVICE REPRESENTATIVE**

NAME: \_\_\_\_\_  
ADDRESS: \_\_\_\_\_  
TELEPHONE: \_\_\_\_\_

## INDEX

<b>A</b>			
Ac Failure Reporting	21	Extended Format,	
Additional Smoke-Detector Power-Up Time	21	see Data Format	22
also see Time Selection, 31, 32;		External Reset Switch	11
Alarm Verification, 21		External Silence Switch	11, 24
Alarm Detection	10, 12	<b>F</b>	
Alarm Relay,		Features	3
see Inhibit Auxiliary Alarm Relay	24	Fire-Drill Test	
Alarm/Trouble Codes,		see Testing the System (Test #4)	16
see Report on Alarm/Trouble	28	<b>G</b>	
also see Data Format, 22, 23; Multi-		Glossary	17, 21-33
panel Systems, 37; Test Timer, 30		Ground Fault,	24
Alarm Verification	21	also see Supervisory Loop, 29	
Anti-Jam Time	21	Grounding	34
Auxiliary Alarm Relay,		<b>H</b>	
see Inhibit Auxiliary Alarm Relay	24	Harnesses, Battery	37
also see Multipanel Systems, 37; Pre-		Heat Detectors	10, 34
Signal Alarm, 27; Time Selection, 31;		Horns/Strobe Horns, Recommended	6
Wiring Diagrams, 42, 43		<b>I</b>	
<b>B</b>		Inhibit Auxiliary Alarm Relay	24
Backup Reporting	22	Inhibit Keypad Digit Beep	24
Battery		Inhibit Keypad Zone/Device Buttons	24
Calculation, see Appendix I	44	Inhibit Signal-Circuit Alarm	25
Capacity, see Specifications	4, 5	Inhibit System-Trouble Resound	25
Installation	35-37	Inhibit Trouble Relay	25
Bells/Strobe Bells, Recommended	6	Inhibit Zone-Enable Resound	25
<b>C</b>		Inhibit Zone-Trouble Resound	25
Chimes/Strobe Chimes, Recommended	7	Inhibit 24-Hour Trouble Reminder	26
Communicator, see DD6000	3, 4, 5, 6, 8, 37	Initiating Circuits	3, 10
Communicator Test,		Installation	34
see Testing the System (Test #2)	15	Batteries	35-36
<b>D</b>		Fire, Typical, see Appendix II	45
Daily Reminder,		<b>K</b>	
see Inhibit 24-Hour Trouble Reminder	26	Keypad,	
Data Format	22-23	Functions	11
DD6000 (Communicator)	3, 4, 5, 6, 8, 37	Operation	12
Device, Disabling/Enabling	12, 14	Overview	10
also see Inhibit Keypad Zone/Device		also see Inhibit Keypad Digit Beep, 24;	
Buttons, 24; Polarity-Reversal Alarm,		Inhibit Keypad Zone/Device Buttons, 24	
26		Keypad Silence Button	26
Devices, Recommended UL-Listed	6	<b>L</b>	
Dial-Tone Detection	24	Low Battery	26
also see Telephone Numbers, 30		also see Ac-Failure Reporting, 21	
<b>E</b>			
Electronic Signals, Recommended	7		
Enable R6000 Outputs	24		

M

M278 (Line-Reversal Module)	3, 6, 9
Also see Multipanel Systems, 37;	
Polarity-Reversal Alarm, 26	
M6000	3, 4, 5, 6, 8, 9, 37
also see Polarity-Reversal Alarm, 26	
Mini-Sounder	2, 10, 11, 13, 14,
	15, 16, 24, 25, 26
Mounting	34
Multipanel Systems	37

N

No Ac, see Ac-Failure Reporting	21
---------------------------------	----

O

One-Man Test,	
see Testing the System (Test #1)	14-15
Operation	12
Ordering Information	6
Outputs	3
Overview	10

P

Polarity-Reversal Alarm	26
Pre-Signal Alarm	27
Pre-Signal Alarm Delay	27
Programming	17
Materials	17
Record Sheets	17, 19-20
Steps	17
PROM	2, 6, 17
Programming	17, 18
Pull Stations	10, 34

R

R6000, see Enable R6000 Outputs	24
Receiver Format	27-28
Recommended UL-Listed Devices	6
Report on Alarm/Trouble	28
also see Polarity-Reversal Alarm, 26	
Resetting an Alarm	10
Resetting a Trouble Indication	13
Restoral Report	28
also see Ac-Failure Reporting, 21;	
Data Format, 23	
Restore Codes, see Restoral Report	28
also see Data Format, 23	
RP6000 (Remote Annunciator)	4, 5, 6, 11

S

Signal Circuit,	
see Inhibit Signal-Circuit Alarm	25

also see Completing the Installation, 38; Keypad Silence Button, 26; Pre-Signal Alarm, 27; Time Selection, 31, 32; Waterflow Zone, 33	
Silencing an Alarm	10, 11, 12
also see Waterflow Zone, 33	
Silencing a Trouble Indication	10, 11, 13
Single-Digit Event Code Format,	
see Data Format	22-23
Smoke Detectors	10, 34
Recommended	7
also see Additional Smoke-Detector Power-Up Time, 21; Alarm Verification, 21	

Sounder, see Mini-Sounder	
Specifications	4, 5
Sprinkler Supervision	9, 12
Status Reporting	29
Strobe Bells	6
Strobe Chimes	7
Strobe Horns	6
Strobes	7
Subscriber Identification Numbers	29
also see Backup Reporting, 22; Extended Format, 22; Restoral Report, 28; Sum Check Format, 23; Test Timer, 30	
Sum-Check Format, see Data Format	23
Supervisory Loop	29
also see Multipanel Systems, 37	
System Test,	
see Testing the System (Test #3)	15
System Trouble	10, 12; 13, 14
Resetting	13
System-Trouble Resound,	
see Inhibit System-Trouble Resound	25

T

Telephone Numbers	30
also see Data Format, 22, 23; Dial-Tone Detection, 24; Restoral Report, 28	
Test Timer	30
also see Status Reporting, 29; Subscriber Identification Numbers, 29; Time Selection, 31	
Testing the System	11, 14
also see Anti-Jam Time, 21; Completing the Installation, 38	
Time-Out	30
also see Completing the Installation, 38; Time Selection, 31	
Time Selection	31
also see Additional Smoke-Detector Power-Up Time, 21; Alarm Verification, 21; Pre-Signal Alarm Delay, 27; Programming Record Sheets, 19, 20; Test	



Timer, 30; Waterflow Retard Time, 33	
Timer Offset, see Test Timer	30
also see Time Selection, 31	
Touch-Tone Dialing	32
Touch-Tone/Rotary Backup	32
Trouble, System	10, 11, 12, 13
Trouble, Zone	10, 11, 12, 13
Trouble Relay,	
see Inhibit Trouble Relay	25
also see Disabling a Zone, 14; External Silence Keypad, 24; Keypad Silence Button, 26; Multipanel Systems, 37; Time Selection, 31	
Trouble Reminder,	
see Inhibit 24-Hour Trouble Reminder	26
Trouble Resound	11, 13
Two-Digit Event Code Format,	
see Data Format	23

U

UL Classifications	8
UL-Listed Devices, Recommended	6
UL Requirements, Summary of	8

V

Verification Power-Off Time,	
see Alarm Verification	21

W

Warning Devices	35
Waterflow Retard Time	33
also see Time Selection, 31	
Waterflow Zone	12, 33
Wiring	35
Wiring Diagrams	42, 43

Z

Zone Disabling/Enabling	11, 12, 14
also see Inhibit Keypad Zone/Device Buttons, 24; Inhibit Zone-Enable Resound, 25	
Zone-Enable Resound,	
see Inhibit Zone-Enable Resound	25
Zone Trouble	10, 11, 12, 13
Zone-Trouble Resound	11, 14
also see Inhibit Zone-Trouble Resound, 25	
Zones, see Initiating Circuits	3, 10
1-Digit (Single Digit) Event Code Format,	
see Data Format	22-23
1-Man Test,	
see Testing the System (Test #1)	14-15
2-Digit Event Code Format,	
see Data Format	23
24-Hour Trouble Reminder,	
see Inhibit 24-Hour Trouble Reminder	26

NOTE: The material contained herein is believed to be correct and up to date at the time of printing. While every effort is made to provide accurate and timely information, NAPCO assumes no liability for damages resulting from the misuse of this information or incurred due to typographical or printing errors.

# MFA6024 WIRING DIAGRAM

**MAGNUM FIRE ALERT-6024**  
**INSTALLATION DIAGRAM**  
 (REFER TO INSTALLATION INSTRUCTIONS W1382)

**NAPCO SECURITY SYSTEMS, INC**  
**AMITYVILLE, N.Y. 11701**

**24 VOLT SYSTEM**  
 UL COMPATIBILITY ID: MFA6024

**APPROVED BY THE NEW YORK CITY BOARD OF STANDARDS AND APPEALS UNDER CALENDAR NUMBER 843-97-SA**

**KEYPAD: TESTING AND SERVICING FUNCTIONS**

<b>TEST ENABLE</b>	1. ONE-MAN TEST	5. SYSTEM TROUBLE DISPLAY
<b>DEVICE DISABLE/ENABLE:</b>	2. SPRINKLER SUPERVISORY DEVICE ACTIVATION TEST	6. SMOKE-DET. RESISTOR FAILURE
1. SIGNAL CIRCUIT	3. SYSTEM TEST	7. BATTERY TROUBLE
2. AUXILIARY RELAY	4. FIRE DRILL	8. PROGRAM FAILURE
3. TROUBLE RELAY	5. GROUND FAULT	
4. DIGITAL COMMUNICATOR	6. DEVICE DISABLE	
	7. BATTERY TROUBLE	
	8. PROGRAM FAILURE	

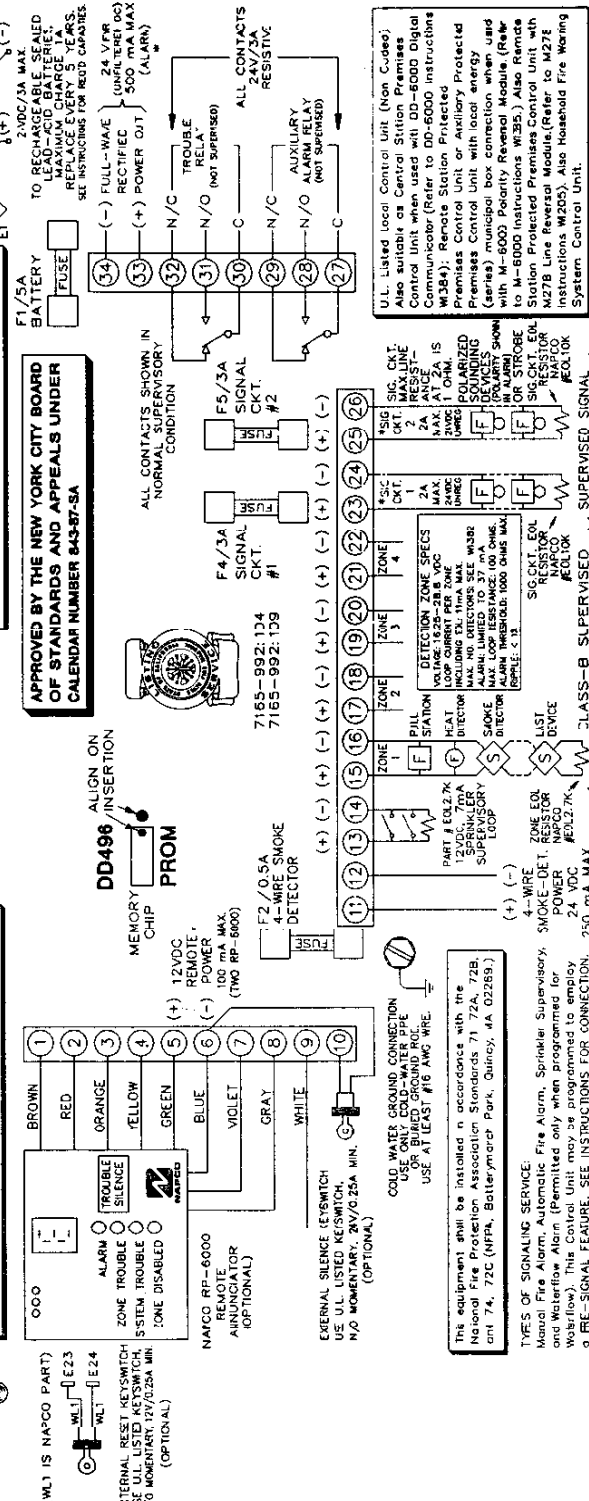

**RESIDENTIAL NOTES:**

- NFPA 74-1978 requires at least one smoke detector as part of a household fire warning system.
- Recognized limited-energy cable must be used for initiating, indicating and supplementary circuits.
- Information describing proper installation, operation, testing, maintenance, evacuation planning, and repair service is to be provided with this equipment.
- Warning: Owner's instructor notice not to be removed.
- Test the system at least once per week in the battery only mode and in the AC and battery mode. Consult with the installation company on how to do this test.

LA594H

# MFA6012 WIRING DIAGRAM

## MAGNUM FIRE ALERT-6012 INSTALLATION DIAGRAM

- KEYPAD: TESTING AND SERVICING FUNCTIONS**
- TEST ENABLE:
1. ONE-MAN TEST
  2. COMMUNICATOR TEST
  3. SYSTEM TEST
  4. FIRE DRILL
- DEVICE DISABLE/ENABLE:
1. SIGNAL CIRCUIT
  2. AUX. ALARM RELAY
  3. TROUBLE RELAY
  4. DIGITAL COMMUNICATOR
- SYSTEM TROUBLE DISPLAY:
1. AC FAILURE
  2. SPRINKLER SUPERVISORY
  3. SPRINKLER SUPERVISORY CIRCUIT
  4. TROUBLE
  5. TROUBLE FAULT
  6. TROUBLE FAULT
  7. TROUBLE FAULT
  8. PROGRAM FAILURE

SPRINKLER SUPERVISORY CIRCUIT TROUBLE INDICATOR (WLT IS NAPCO PART)

EXTERNAL RESET KEYSWITCH USE ULL LISTED KEYSWITCH, 12V/0.25A MIN. (OPTIONAL)



TO RECHARGEABLE SEALED LEAD ACID BATTERY CHARGE 12VDC. REPLACE EVERY 5 YEARS. SEE INSTRUCTIONS FOR RECHARGING.

12VDC/0.25A MIN. BATTERY

12VDC/0.25A MIN. BATTERY

12VDC/0.25A MIN. BATTERY

APPROVED BY THE NEW YORK CITY BOARD OF STANDARDS AND APPEALS UNDER CALENDAR NUMBER 843-87-SA

12 VOLT SYSTEM

U. COMPATIBILITY: ID: MPT12A

Combined alarm output (signal circuits plus full wave rectified power), 2.5A max.

Combined standby output (remote power, 4-wire smoke power, full power in standby), 250mA max.

ALL OUTPUT CIRCUITS POWER LIMITED.

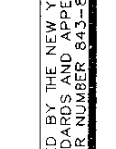

ALIGN ON INSERTION

MEMORY CHIP

7165-992:104

7165-992:109

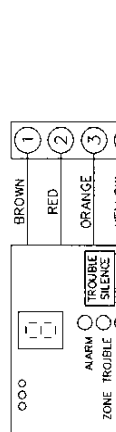

EXTERNAL SILENCE KEYSWITCH USE ULL LISTED KEYSWITCH, 12V/0.25A MIN. (OPTIONAL)

COLD WATER GROUND CONNECTION USE ULL LISTED KEYSWITCH, 12V/0.25A MIN. (OPTIONAL)

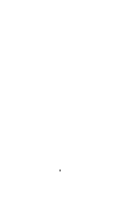

U.L. Listed Local Control Unit (Non-Cased). Also suitable as Central Station Premises Control Unit when used with DD-6000 Digital Smoke Detector (Refer to DD-6000 Instructions for details). U.L. Listed Local Control Unit with Auxiliary Power Premises Control Unit with local energy (series) municipal box connection module (Refer to M-6000 Polarity Inversion Module (Refer to M-6000 Instructions W385). Also female Station Protected Premises Control Unit with M278 Line Reversal Module. (Refer to M278 Instructions W205). Also Household Fire Warning System Control Unit.

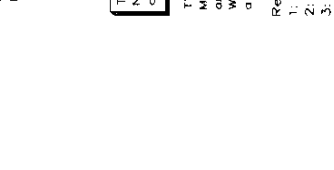
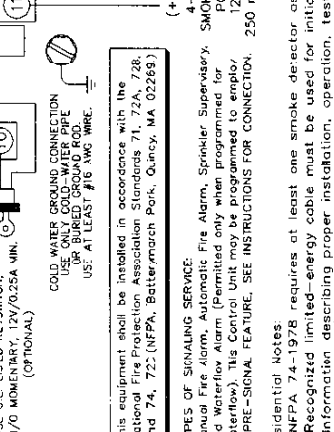
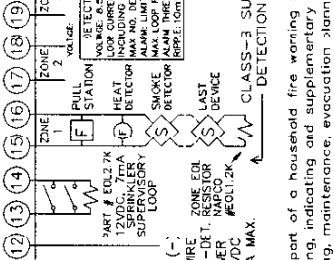
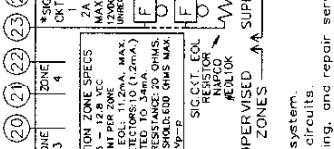
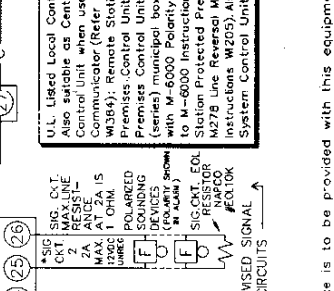
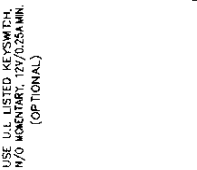
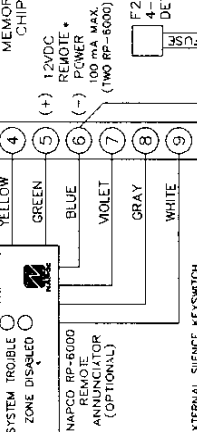
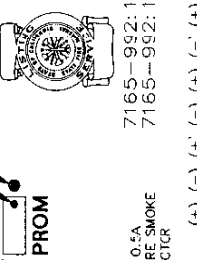
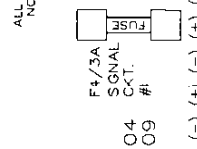
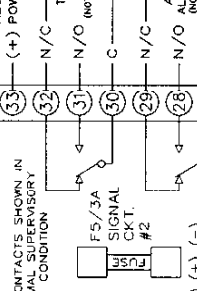

RESIDENTIAL NOTES:

1. NFPA 74-1978 requires at least one smoke detector as part of a household fire warning system.
2. Recognized limited-energy cable must be used for initiating, indicating and supplementary circuits.
3. Information describing proper installation, operation, testing, maintenance, evacuation planning, and repair service is to be provided with this equipment.
4. Warning: Owner's instruction notice not to be removed.
5. Test the system at least once per week in the battery only mode and in the AC and battery mode. Consult with the installation company on how to do this test.

U.L. Listed Local Control Unit (Non-Cased). Also suitable as Central Station Premises Control Unit when used with DD-6000 Digital Smoke Detector (Refer to DD-6000 Instructions for details). U.L. Listed Local Control Unit with Auxiliary Power Premises Control Unit with local energy (series) municipal box connection module (Refer to M-6000 Polarity Inversion Module (Refer to M-6000 Instructions W385). Also female Station Protected Premises Control Unit with M278 Line Reversal Module. (Refer to M278 Instructions W205). Also Household Fire Warning System Control Unit.

LA 69 46

## APPENDIX I. STANDBY-BATTERY CALCULATION

Sample ratings for standby-battery capacity (energy) as a function of combined standby current are shown in Tables 1 and 2 for the MFA6024 and MFA6012 respectively (see SPECIFICATIONS). If one of the sample values is found to be suitable, battery capacity need not be calculated. Otherwise, use the procedure given below to determine the required capacity in ampere-hours (AH). If the maximum alarm current does not exceed 2.5A, the battery will supply the listed combined standby current for the standby time shown followed by a 5-minute alarm. (Loop currents and subassemblies have been included in these specifications.)

It is not totally accurate to merely multiply the combined standby current by the standby time to obtain the battery capacity since other factors (such as control-panel charging capabilities, temperature, battery condition, etc.) affect battery operation. However, for those who want to calculate the theoretical *minimum* capacity required, we provide the following worksheet.

### Standby Currents

Control-Panel Standby Current (Loop currents and M6000 or DD6000 are included) 0.18 x \_\_\_\_\_ hours = \_\_\_\_\_ (1)

Number of RP6000s: \_\_\_\_\_ x 0.05 x \_\_\_\_\_ hours = \_\_\_\_\_ (2)

Number of CA6000s: \_\_\_\_\_ x 0.026x \_\_\_\_\_ hours = \_\_\_\_\_ (2a)

### Alarm Currents

Alarm Factor, F: Alarm Time \_\_\_\_\_ minutes divided by 60 = \_\_\_\_\_  
(For 5 minutes, F = 0.083)

Number of Bells: \_\_\_\_\_ x Current (ea.) \_\_\_\_\_ amps x F \_\_\_\_\_ = \_\_\_\_\_ (3)

Maximum Loop Alarm Current: 0.12 x F \_\_\_\_\_ = \_\_\_\_\_ (4)

Required Battery Capacity (Add lines 1 through 4) -----> = \_\_\_\_\_AH

(Use the following space for calculations)

## APPENDIX II. TYPICAL FIRE INSTALLATION

At least one smoke detector should be installed directly outside each sleeping area. If there is more than one floor, additional smoke detectors should be installed on each level, including the basement. The living-area and basement smoke detectors should be installed near the stairway of the next upper level.

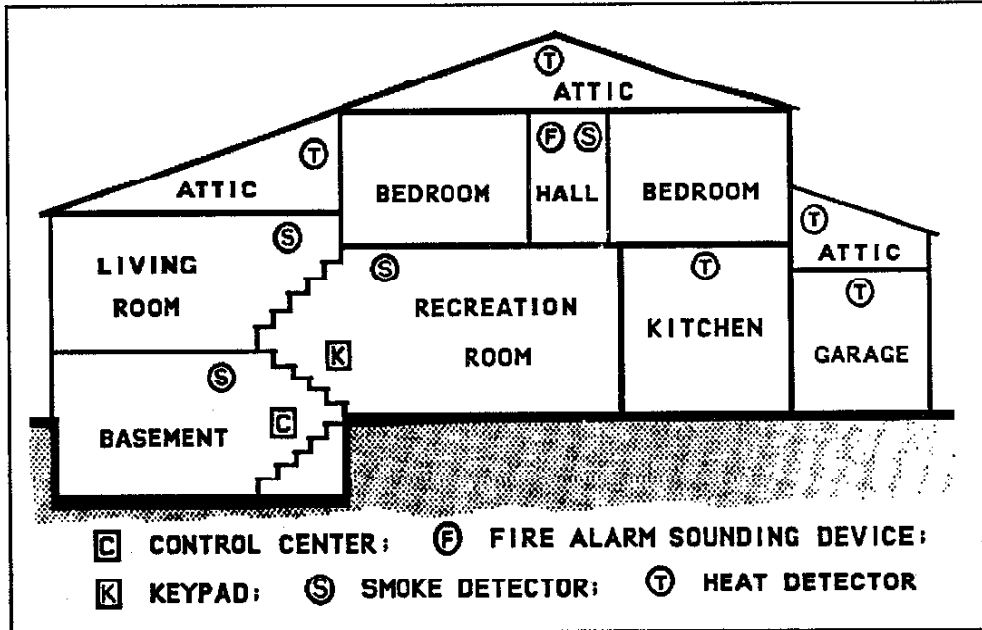

For increased protection, additional detectors should be installed in areas other than those required, such as dining rooms, individual bedrooms, furnace rooms, utility rooms and hallways. Heat detectors, rather than smoke detectors, are recommended in garages, attics, and kitchens due to conditions that may result in false alarms and improper operation. Large areas and areas with partitions, ceiling beams, doorways, and open joists will require additional detectors. Refer to NFPA Standard 74 (National Fire Protection Association, Batterymarch Park, Quincy, MA 02269) for additional information, including proper mounting methods.

## NAPCO LIMITED WARRANTY

**N**APCO SECURITY SYSTEMS, INC. (NAPCO) warrants its products to be free from manufacturing defects in materials and workmanship for fifteen months following the date of manufacture. NAPCO will, within said period, at its option, repair or replace any product failing to operate correctly without charge to the original purchaser or user.

This warranty shall not apply to any equipment, or any part thereof, which has been repaired by others, improperly installed, improperly used, abused, altered, damaged, subjected to acts of God, or on which any serial numbers have been altered, defaced or removed. Seller will not be responsible for any dismantling or reinstallation charges.

In case of defect, contact the security professional who installed and maintains your security system. NAPCO shall have no obligation under this warranty, or otherwise, if the product has been repaired by others, improperly installed, improperly used, abused, altered, damaged, subjected to accident, nuisance, flood, fire or acts of God, or on which any serial numbers have been altered, defaced or removed. NAPCO will not be responsible for any dismantling, reassembly or reinstallation charges.

In order to exercise the warranty, the product must be returned by the user or purchaser, shipping costs prepaid and insured to NAPCO. After repair or replacement, NAPCO assumes the cost of returning products under warranty.

*There are no warranties, express or implied, which extend beyond the description on the face hereof. There is no express or implied warranty of merchantability or a warranty of fitness for a particular purpose. Additionally, this warranty is in lieu of all other obligations or liabilities on the part of NAPCO.*

Any action for breach of warranty, including but not limited to any implied warranty of merchantability, must be brought within the six months following the end of the warranty period. In no case shall NAPCO be liable to anyone for any consequential or incidental damages for breach of this or any other warranty, express or implied, even if the loss or damage is caused by the seller's own negligence or fault.

*This warranty contains the entire warranty. It is the sole warranty and any prior agreements or representations, whether oral or written, are either merged herein or are expressly cancelled. NAPCO neither assumes, nor authorizes any other person purporting to act on its behalf to modify, to change, or to assume for it, any other warranty or liability concerning its products.*

In no event shall NAPCO be liable for an amount in

excess of NAPCO's original selling price of the product, for any loss or damage, whether direct, indirect, incidental, consequential, or otherwise arising out of any failure of the product. Seller's warranty, as hereinabove set forth, shall not be enlarged, diminished or affected by and no obligation or liability shall arise or grow out of Seller's rendering of technical advice or service in connection with Buyer's order of the goods furnished hereunder.



**NAPCO RECOMMENDS THAT THE ENTIRE SYSTEM BE COMPLETELY TESTED WEEKLY.**

**Warning:** Despite frequent testing, and due to, but not limited to, any or all of the following; criminal tampering, electrical or communications disruption, it is possible for the system to fail to perform as expected. NAPCO does not represent that the product/system may not be compromised or circumvented; or that the product or system will prevent any personal injury or property loss by burglary, robbery, fire or otherwise; nor that the product or system will in all cases provide adequate warning or protection. A properly installed and maintained alarm may only reduce risk of burglary, robbery, fire or otherwise but it is not insurance or a guarantee that these events will not occur. **CONSEQUENTLY, SELLER SHALL HAVE NO LIABILITY FOR ANY PERSONAL INJURY, PROPERTY DAMAGE, OR OTHER LOSS BASED ON A CLAIM THE PRODUCT FAILED TO GIVE WARNING.** Therefore, the installer should in turn advise the consumer to take any and all precautions for his or her safety including, but not limited to, fleeing the premises and calling police or fire department, in order to mitigate the possibilities of harm and/or damage.

NAPCO is not an insurer of either the property or safety of the user's family or employees, and limits its liability for any loss or damage including incidental or consequential damages to NAPCO's original selling price of the product regardless of the cause of such loss or damage. If the user wishes to protect itself to a greater extent, NAPCO will, at user's sole cost and expense, obtain an Insurance policy to protect the user, supplemental to user's own policy, at a premium to be determined by NAPCO's insurer upon written notice from user by Certified Mail. Return Receipt Requested, to NAPCO's home office address, and upon payment of the annual premium cost by user.

Some states do not allow limitations on how long an implied Warranty lasts or do not allow the exclusion or limitation of incidental or consequential damages, or differentiate in their treatment of limitations of liability for ordinary or gross negligence, so the above limitations or exclusions may not apply to you. This Warranty gives you specific legal rights and you may also have other rights which vary from state to state.

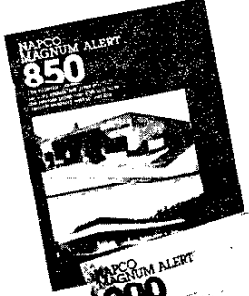
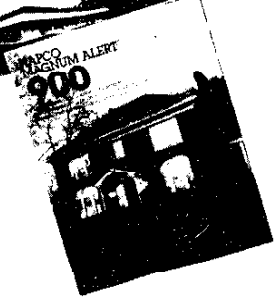
Sales aids prepared by Napco help you move more products and earn more profits. Order now to start putting this carefully researched material to work for you. Fill out this order form (both sides) and mail it with your check or money order payable to Napco. Or call Napco today for the name of your nearest stocking distributor. (See reverse side for toll-free numbers and address.)

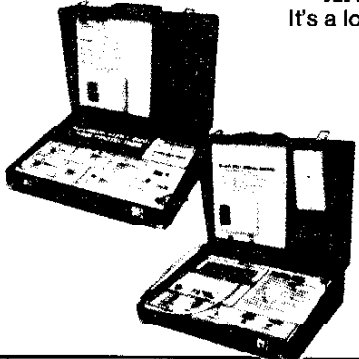
		QUANTITY	AMOUNT
    	<p><b>NAPCO CUSTOMER LITERATURE</b>            Full-color folders in easily understandable language. Show how each system protects the customer's home or business. Ideal for sales presentations, mailers, etc.            Priced \$9.00 per 100 (Sold in lots of 100)</p> <p>Magnum Alert-700 Security System (A177) <input type="checkbox"/></p> <p>Magnum Alert-800 Security System (A166) <input type="checkbox"/></p> <p>Magnum Alert-825 Security System Residential (A218) <input type="checkbox"/></p> <p>Commercial (A218 COM) <input type="checkbox"/></p> <p>Magnum Alert-850 Security System Residential (A221) <input type="checkbox"/></p> <p>Commercial (A221 COM) <input type="checkbox"/></p> <p>in French, Residential (A239) <input type="checkbox"/></p> <p>in French, Commercial (A239 COM) <input type="checkbox"/></p> <p>Magnum Alert-854 Security System Residential (A245) <input type="checkbox"/></p> <p>Commercial (A245 COM) <input type="checkbox"/></p> <p>Magnum Alert-900 Security System Residential (A191) <input type="checkbox"/></p> <p>Commercial (A191 COM) <input type="checkbox"/></p> <p>Shock Guard (A186) <input type="checkbox"/></p>		
	<p><b>NAPCO PROPOSAL FOLDER</b>            Pocketed folder for literature, technical sheets and proposals. Helps you wrap up sales with a professional look.            Literature Folder (A176) .75 each <input type="checkbox"/></p>		
	<p><b>NAPCO SALES &amp; TECHNICAL GUIDE</b>            Binder contains: Sales literature; Working instructions for all products; Engineering updates and Memos; Troubleshooting guides. You are placed on a select mailing list to receive all future updates.            Binder (A173) \$24.95 each <input type="checkbox"/></p>		
	<p><b>NAPCO BRIEFCASE DEMONSTRATORS</b>            It's a lot easier to close sales by demonstrating the system right at your customer's premises.</p> <p>Magnum Alert-800 Demonstrator Case (SDC/800) \$299.95 each <input type="checkbox"/></p> <p>Magnum Alert-825 Demonstrator Case (SDC/825) \$299.95 each <input type="checkbox"/></p> <p>Magnum Alert-850 Demonstrator Case (SDC.850A) \$249.95 each <input type="checkbox"/></p> <p>(Add \$2.50 for freight)</p>		
	<b>TOTAL</b>		

TEAR HERE

I'd like to preview your Consumer Literature first. Please send a free copy of the item(s) checked below:

- |  |   |
|--|---|
| <input type="checkbox"/> Magnum Alert-700 Security System          | <input type="checkbox"/> Magnum Alert-854 Security System |
| <input type="checkbox"/> Magnum Alert-800 Security System          | <input type="checkbox"/> Magnum Alert-900 Security System |
| <input type="checkbox"/> Magnum Alert-825 Security System          | <input type="checkbox"/> Shock Guard                      |
| <input type="checkbox"/> Magnum Alert-850 Security System          | <input type="checkbox"/> Napco Proposal Folder            |
| <input type="checkbox"/> Magnum Alert-850 Security System (French) |   |

Enclosed is my check/money order for \$ \_\_\_\_\_ to cover the Napco sales aids ordered on the reverse side.

NAME \_\_\_\_\_

TITLE \_\_\_\_\_

COMPANY \_\_\_\_\_

ADDRESS \_\_\_\_\_

CITY \_\_\_\_\_ STATE \_\_\_\_\_ ZIP \_\_\_\_\_

TELEPHONE \_\_\_\_\_



SALES DEPARTMENT  
**NAPCO SECURITY SYSTEMS, INC.**  
333 Bayview Avenue, Amityville, NY 11701

PLACE  
STAMP  
HERE

SALES DEPARTMENT  
**NAPCO SECURITY SYSTEMS, INC.**  
333 Bayview Avenue  
Amityville, New York 11701

**SEND NOW FOR  
YOUR NAPCO  
BUSINESS  
BUILDERS.**